



IEC61000-3
HARMONICS & FLICKER
SOFTWARE FOR THE
PM6000
USER MANUAL

VPN: 98-113 Issue: 4.0

April 2010

Voltech Instruments is committed to a policy of continuous product development. Hence product specification and the information given in this manual are subject to change without notice.

No part of this publication may be reproduced, stored in a retrieval system or transmitted in any form or by means electronic, mechanical photocopying, recording or otherwise without prior written permission of Voltech Instruments.

All rights reserved.

© Voltech Instruments 1997-2010

Microsoft, Windows and the Windows logo are either registered trademarks or trademarks of Microsoft Corporation in the United States and/or other countries.

Thank you for purchasing this Voltech software. Should you experience any difficulty during the installation or use of this software, please do not hesitate to contact your supplier or one of the Voltech main offices listed below and ask for assistance.

Voltech Instruments Inc.

11637 Kelly Road
Suite 306
Fort Myers, FL 33908
USA
Tel: +1 239 437 0494
Fax: + 1 239 437 3841

Voltech Instruments Ltd.

148 Sixth Street
Harwell International Business Centre
Harwell, Didcot, Oxon OX11 0RA
UK
Tel. +44 (0)1235 834555
Fax. +44 (0)1235 835016

sales@voltech.com

Table of Contents

1. Introduction	1
1.1. Standards Implemented By This Software	1
1.2. How These Standards are Referenced	4
1.3. General	5
2. What is IEC61000-3?.....	6
2.1. Background	6
2.2. Test Equipment Required.....	9
2.3. Equipment Classification	13
2.4. Limits	16
3. Installation	18
3.1. PC Requirements.....	18
3.2. IEEE 488 Interface Cards supported.....	19
3.3. Power Analyzers Supported.....	19
3.4. Installing the Software To Your PC.....	20
3.5. Registering the Software.....	21
3.6. Transferring the Software to a Different PC.....	22
3.7. Setting up your IEEE488 interface card	23
4. Getting Started	26
4.1. Starting the Software.....	26
4.2. Setting Up the Test Equipment	26
4.3. Set-up Power Analyzer and AC Source Communications	27
4.4. Setup AC Source.....	30
4.5. Power Analyzer Shunt and Scaling.....	34
4.6. Entering a New Product	35
4.7. Configuring a Fluctuating Harmonics Test.....	38
4.8. Performing a Harmonics Test	42
4.9. Changing Test Details	44
4.10. Viewing Results	45
4.11. Viewing Fluctuating Harmonics Results	46
4.12. Performing a Repeatability Test	56
4.13. Performing a Flicker Test	58
4.14. Performing a Manual Switching Test	65

4.15. Results Printing	67
4.16. Results Export	69
4.17. Exiting from the IEC1000-3 Software	69

5. On-Line Help..... 70

6. Reference Information..... 74

6.1. How the Analyser Performs a Harmonics Test.....	74
6.2. Glossary of Terms	78
6.3. Equipment without limits	81
6.4. Control Methods Not Allowed.....	81
6.5. IEC61000-3-2 harmonics test duration	83
6.6. Harmonic Test Conditions IEC61000-3-2	84
6.7. Flicker Test Conditions IEC61000-3-3:2008.....	91

7. Release History..... 100

1. INTRODUCTION

Welcome to the Voltech IEC61000-3 Harmonics and Flicker Software for the PM6000. Voltech has been leading the field in providing IEC harmonics measurement solutions for over 10 years now, and with this edition of the software (details below) Voltech continues to provide a complete measurement solution that is accurate, easy to use and in complete accordance with the requirements of the relevant standards.

This manual is intended to accompany version 1.15.07 of the software, which was released in May 2010. The software version is displayed in the software in the 'About' section of the 'Help' menu.

This version of the software is designed to work with Voltech's PM6000 power analyzer. It will not function with any other model of power analyzer.

1.1. STANDARDS IMPLEMENTED BY THIS SOFTWARE

Together with the Voltech PM6000, this software tests to the standards listed below. As these standards are under constant review, it is the responsibility of the user to ensure that the correct version of a standard is being used. This is usually the most recent version of the standard available. For the most up-to-date guidance and upgrades, please see our website at www.voltech.com.

At the time of the publication of this manual in September 2007, the IEC Standard 61000-4-7 (Guide to Harmonics and Interharmonics Measurements) is in a transitional state. The PM6000 complies with the latest requirements, including the measurements of inter-harmonic groups. Product placed on the market after the end of 2007 should be measured in

accordance with this requirement, hence all new product testing should now be done using these methods.

For testing to the previous version in accordance to IEC61000-4-7: 1993 which included amendment 14 (A14) but not “inter-harmonics” the Voltech PM3000-002 power analyzer can be used with its own version of 32 bit software, (part number 250-024). Remember that this standard has a date of withdrawal of 30th December 2007 and is no longer recommended for use.

The standards implemented are:

Harmonics

IEC61000-3-2:2000 + A2:2005

Latest date of publication: September 2005

Date of withdrawal of previous standards: December 2007

IEC61000-3-2: 2005 + A1:2008 +A2:2009

Latest date of publication: September 2005

Date of withdrawal of previous standards: December 2007

IEC61000-4-7 (2001) – Testing and measurement techniques

(The PM6000 and this software comply fully with the requirements for 200mS measuring windows and inter-harmonic grouping).

IEC61000-4-7 (1993) – Testing and measurement techniques

(The PM6000 and this software comply fully with the requirements for 200mS measuring windows and non inter-harmonic grouping).

Flicker

IEC61000-3-3 1995 First Edition

Date of withdrawal of previous standards: January 2001.

(This date of withdrawal makes the previous standards IEC555-3 and EN60555-3 obsolete).

IEC61000-3-3 1995 Incorporating Amendment No. 1 (2001)

(Including requirements for manual switching).

IEC61000-3-3 1995 Incorporating Amendment No.2 (2005)

(Change of test conditions for tumble dryers)

IEC61000-4-15 2003 Flicker - Functional and Design Specifications

(This standard defines the flickermeter required for IEC61000-3-3 testing.)

Standards

The standards discussed here are published by the IEC (www.iec.ch) and implemented by national bodies such as BSI (www.bsi.org.uk). Copies may be purchased from them and it is always the users responsibility to ensure that they are making measurements in accordance with the regulations and standards in force at the time of test.

1.2. HOW THESE STANDARDS ARE REFERENCED

IMPORTANT:

Because of the various bodies that issue standard, the following applies:

IEC61000-3-2:2000 + A2:2005 and EN61000-3-2:2001 + A2:2005 are referred to as:

'EN61000-3-2 2001' or the **'2001'** version

IEC61000-3-2:2005 is referred to as:

EN61000-3-2:2006 or **'2006'** version

Note:

All products should be tested to the latest published standard.

1.3. GENERAL

The Software runs on a PC, and works with the Voltech PM6000 Power Analyzer and the ac source of your choice. The PM6000 needs to be connected to the PC using the RS232 port. If a programmable ac source is used for full-compliance testing then it can use either an RS232 or a GPIB interface. An RS232 to GPIB converter can be connected to the PM6000 to allow GPIB control of the instrument. One example is the National Instruments GPIB-232CV-A that has been reliably used with the PM6000 at 38400 baud.

Not only does the software allow you to quickly set up the tests to be done, but it then also goes on to control the ac source and Power Analyzer to make the measurements. It then reads back the measurement data, and presents the results in easy-to-read tables and graphs, including comparisons with the specification limits and highlighting the Passes and Fails.

When the test is finished, all results can be archived to disk, printed or passed on to another application, for example to be included in a document produced by a word processor.

2. WHAT IS IEC61000-3?

The specifications IEC61000-3-2/3 (equivalent to EN61000-3-2/3) and their now obsolete predecessors IEC60555-2/3 are concerned with low frequency emissions on the power supply connection of equipment rated at less than 16 Amps per phase.

The standards specify limits for:

- a) The distortion of the current waveform drawn by equipment.
- b) The voltage changes that the equipment may impose on the supply line when connected.

2.1. BACKGROUND

Historically, the need for IEC61000-3 has come about due to the increased use of electronic circuits in controlling the power taken by products from the ac supply.

Before the advent of power electronics, most loads connected to the ac supply lines were resistive (e.g. filament lamps and heaters) or inductive (e.g. fixed speed ac motors). The currents taken by such loads are sinusoidal, and do not cause any special problems to the ac supply.

Today almost every product - computers, television and audio equipment, lamp dimmers, variable speed motor control in portable tools and washing machines, (the list is almost endless) - uses some form of electronic power supply capable drawing a highly distorted (non-sinusoidal) current.

As an example, the simple rectifying circuit seen at the input to many switch-mode power supply designs presents a highly distorted load, which draws current only at the peak of the voltage waveform.

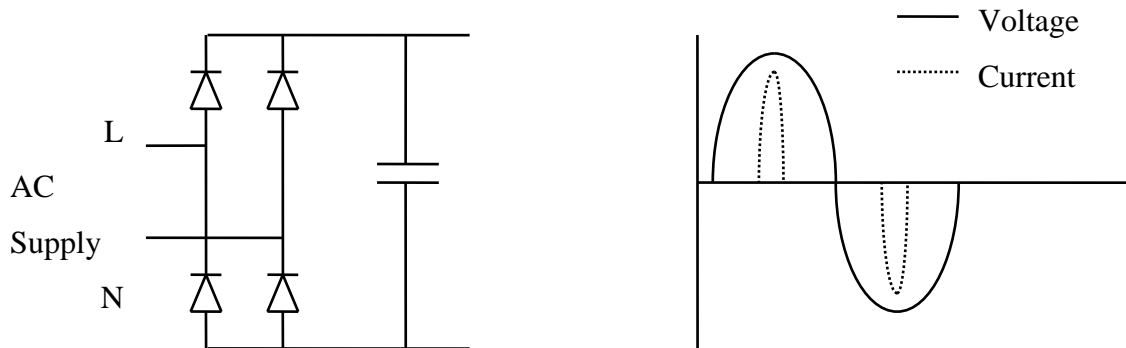

Distorted current waveforms are undesirable because they can lead to several problems in the ac supply. Examples include: reduction of power factor, causing excessive heat losses in the transmission cables, and excessive neutral currents in balanced three phase systems; and distortion of the supply voltage, which may interfere with other equipment using the same supply.

In the particular case of the switch mode power supply example shown above, IEC61000-3-2 would impose limits on the amplitude of each harmonic of the current.

Another subject covered by the IEC61000-3 specifications is fluctuations in load.

Nowadays, more and more products are incorporating controls such as timers and thermostats, which can cause frequent changes to the load seen by the supply. Examples are cooking appliances, heaters air conditioners and photocopiers.

The problem that this may cause can be seen in the situation where several appliances are connected to the 'same' ac source (say within a building) and one of the appliances is presenting a fluctuating load to the supply. The ac supply must have a certain amount of source impedance between the generator and distribution point (i.e. the building), and therefore the fluctuating current taken by one appliance will produce a fluctuating voltage drop across this source impedance, resulting in a fluctuating source voltage being presented to the other appliances connected to the same distribution point.

Of crucial importance is the effect caused by the changing supply voltage in the light output of a filament lamp. This output is proportional to the square of the source voltage, and therefore even small changes of voltage can cause significant changes in light intensity. The effect on a human observer of this variation of light output is known as flicker.

IEC61000-3-2 specifies separately the limits for the harmonic amplitudes of the current taken by a fluctuating load. It also specifies two tests for the voltage disturbance produced by load currents flowing in a given source impedance: a maximum voltage deviation test and a flicker test; these should be applied to all equipment.

2.2. TEST EQUIPMENT REQUIRED

The following circuits show examples of how to connect the test equipment when testing products to the IEC61000-3 specifications:

a) Full Compliance Testing

Full compliance testing is required by test laboratories offering traceable certification to customers that their products meet the required standard. In this case, all the test equipment used (ac source, reference impedance and Power Analyzer) has to meet all the requirements of the IEC61000-3 specification.

Harmonic Current Measurements

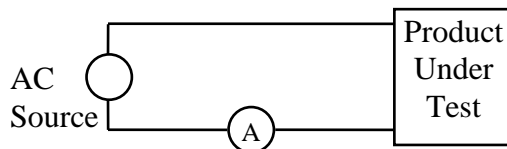

Flicker and Voltage Deviation Measurements

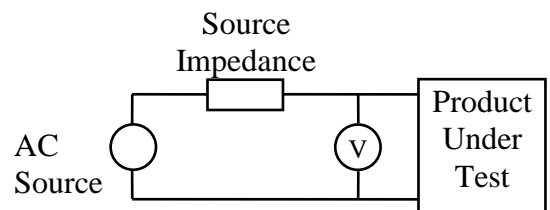

Equipment Required

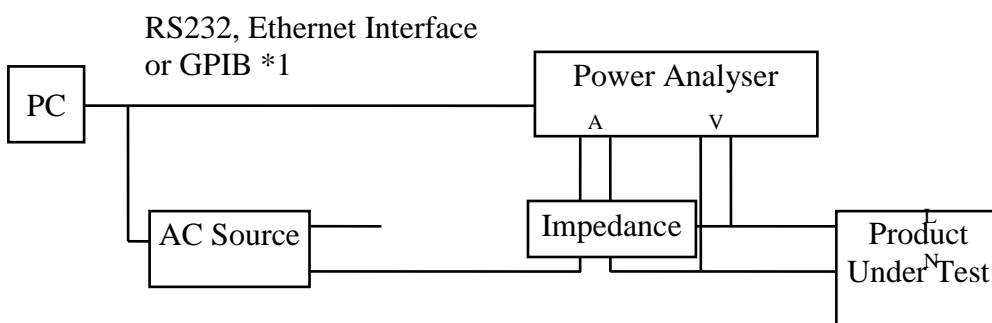

***1:** An RS232 to GPIB converter will be needed for GPIB control of the PM6000.

Power Analyzer The Voltech PM6000 with version 1.08.01 firmware or greater is required for full compliance testing.

Impedance Network The Voltech 'IEC Reference Impedance Network' should be used. It is equipped with a shorting link to allow you to switch out the impedance (when measuring the current harmonics) without rewiring.

AC Source You may use the programmable ac source of your choice. Ensure that it is fully compliant with the requirements of IEC61000-3, and that it has a dynamic output impedance of less than 20m Ω .

Wiring The wiring must have the effect of adding less than 10m Ω to the impedance network. Suitable leads are supplied with the Voltech Reference Impedance Network.

b) Pre-Compliance Testing

Pre-compliance testing requires a test environment that can give a high degree of confidence that the product meets the required specification, but without the traceability of full compliance. This environment is less expensive to create on your own site, and could be used for the initial testing of new products. As well as giving valuable

feedback to engineering departments during product development, it will also give confidence that your product should meet the requirements of the standard when it is eventually submitted to a fully compliant test house for certification.

Harmonic Current Measurements

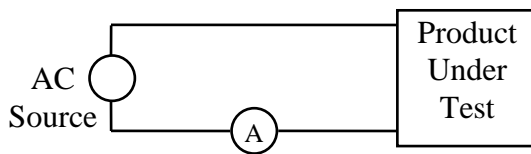

Flicker and Voltage Deviation Measurements

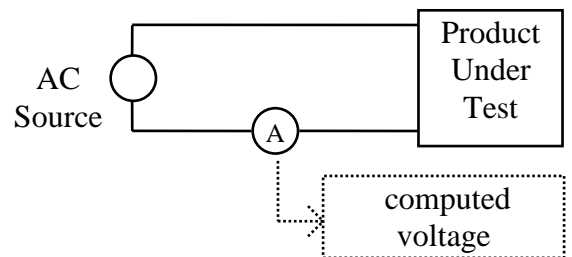

Equipment Required

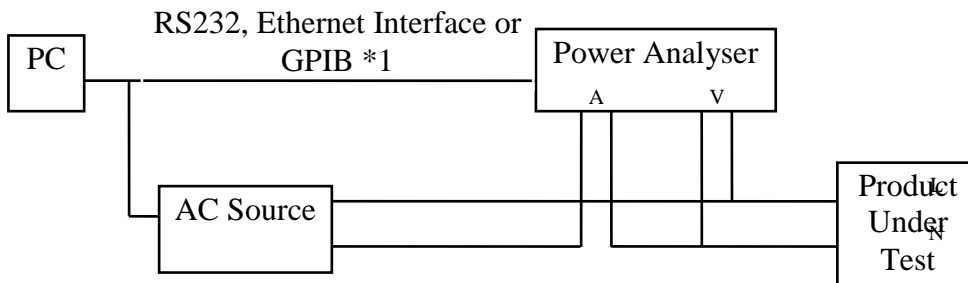

***1:** An RS232 to GPIB converter will be needed for GPIB control of the PM6000.

Power Analyzer Again, you must use the Voltech PM6000 Analyser.

Impedance Network Not needed, as the PM6000 Analyser can compute the flicker and voltage deviations from the measured current and the

theoretical value of the reference impedance.

AC Source

A low cost alternative to a programmable ac source is to use the regular ac supply. Choose an outlet where the voltage is as clean and as stable as possible. As the IEC61000-3 Software includes voltage source qualification, the quality of your source is known at all times.

In general, if your product meets the standard with a good margin when testing with your ac line voltage, there should be no problems when you submit it for fully compliant testing.

Wiring

Without the measurement of voltage drop across the Impedance Network, the requirement for very low impedance wiring can be relaxed slightly. Less than 100m Ω of wiring impedance will be adequate.

2.3. EQUIPMENT CLASSIFICATION

Equipment classification details for the old '1995' version of the standard may be found in the 'Help' system provided with the software.

Class A equipment is defined as:

- Balanced three-phase equipment
- Household appliances excluding equipment defined to be Class D
- Tools excluding portable tools
- Dimmers for incandescent lamps
- Audio equipment
- Equipment not specified in one of the three other classes

Class B equipment is defined as:

- Portable tools

Class C equipment is defined as:

- Lighting equipment

Class D equipment is defined as:

Equipment having a specified power less than or equal to 600W, of the following types:

- Personal computers and personal computer monitors;
- Television receivers

Class D limits are reserved for equipment that, by virtue of:

- *Number in use;*
- *Duration of use;*
- *Simultaneity of use;*
- *Power consumption;*

- *Harmonic spectrum including phase.*

Can be shown to have a pronounced effect on the public electricity supply system.

Such equipment 'may be reclassified in a future edition of the standard.'

The following 'flowchart for determining conformity' is defined by figure Z1 of the standard:

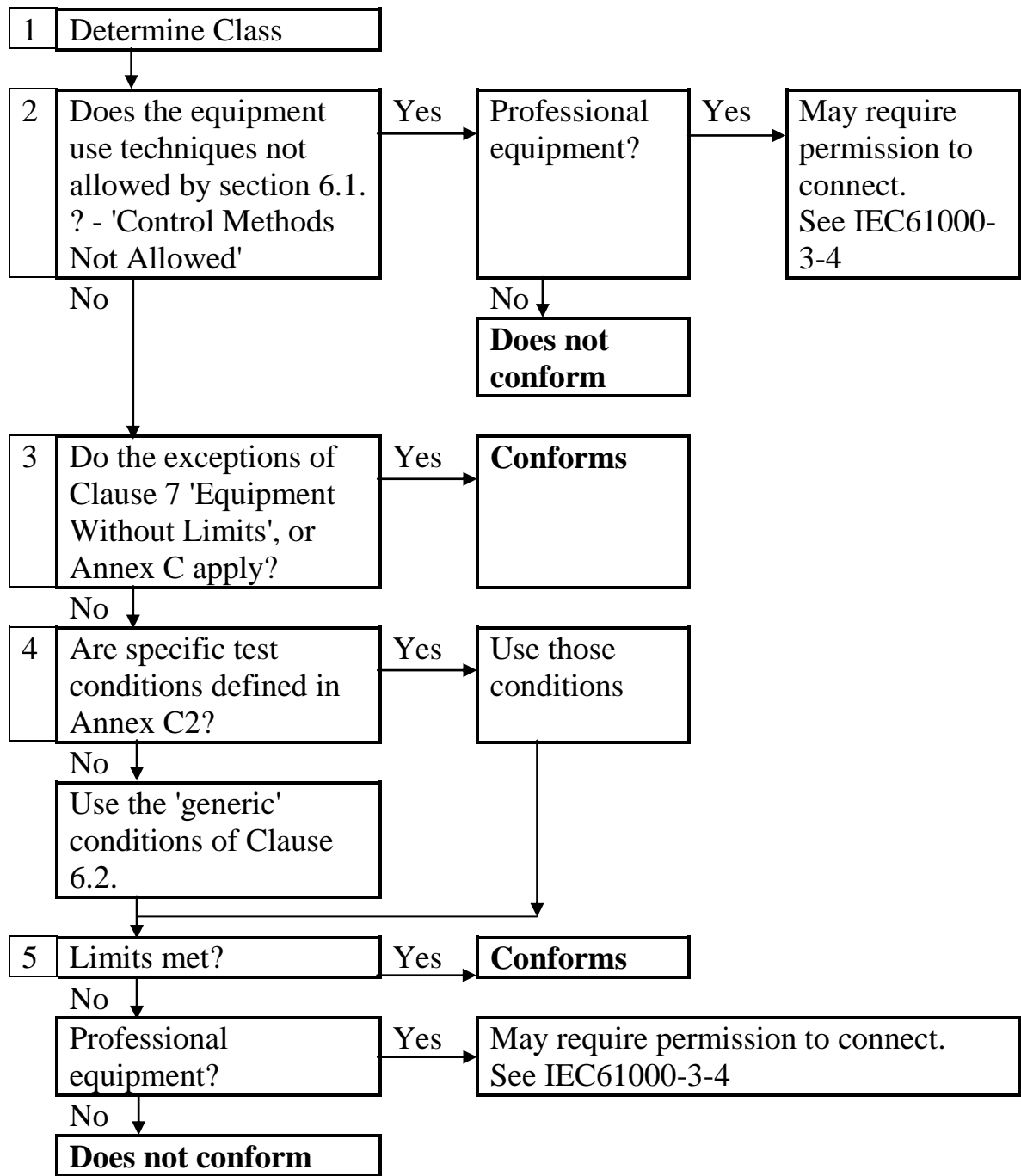

Please refer to the latest available version of the standard before making conformity decisions based on this flowchart.

2.4. LIMITS

The IEC1000-3-2 standard gives tables for each of the four Classes for the maximum permissible harmonic currents for harmonic tests. (These limits are the same for both the 2001 and 2006 versions of the standard. The differences in the two versions of the standard are mainly in the way that the harmonic results are manipulated and compared to these limits).

Maximum Permitted Harmonic Current				
Harmonic (n)	Class A (Amps)	Class B (Amps)	Class C (% of Fund)	Class D (mA/W)
Odd Harmonics				
3	2.30	3.45	30 x λ	3.4
5	1.14	1.71	10	1.9
7	0.77	1.155	7	1.0
9	0.40	0.60	5	0.5
11	0.33	0.495	3	0.35
13	0.21	0.315	3	3.85/13
15 ≤ n ≤ 39	0.15 x 15/n	0.225 x 15/n	3	3.85/n
Even Harmonics				
2	1.08	1.62	2	-
4	0.43	0.645	-	-
6	0.30	0.45	-	-
8 ≤ n ≤ 40	0.23 x 8/n	0.345 x 8/n	-	-

Notes: 1) For Class A and B, the limits are specified as a number of Amps.

2) For Class C the limits refer to a percentage of the fundamental.

λ = the power factor.

- 3) For Class D, the limits vary with the power consumed, and are specified as either the mA/W limit, or the Class A limit, whichever is the smaller.

Limits 2006 :Application of limits Section 6.2.3.3

The average values for the individual harmonic currents, taken over the entire test observation period shall be less than or equal to the applicable limits.

For each harmonic order, all 1.5s smoothed rms current values, as defined in 6.2.2, shall either:

- a) Less than or equal to 150% of the applicable limits or
- b) Less than or equal to 200% of the applicable limits under the following conditions, which apply all together
 1. The EUT belongs to Class A for harmonics
 2. The excursion beyond 150% of the applicable limits less than 10% of the test observation period or in total 10 min (within the test observation period), whichever is smaller, and
 3. The average value of the harmonic current, taken over the entire test observation period, is less than 90% of the applicable limits.

3. INSTALLATION

3.1. PC REQUIREMENTS

Operating System:

Windows 95, 98, 2000 or XP. Windows 3.x is not supported.

PC:

200MHz Pentium II or higher

RAM: 32Mb min

Disk: 2Mb of hard disk space for program installation

- Plus:
- i) at least 1Mb for recording test data
 - ii) PCI local bus 16550 based RS232 interface

The requirements for results storage for each type of test are as follows:

Steady State Harmonics:	1kb per measurement
Fluctuating Harmonics:	7Mb per hour
Flicker:	5kb per 10 minutes

IMPORTANT:

Your Voltech IEC61000-3 software operates in 'Real Time'. This means that during execution of a test, limits and results are being computed and displayed simultaneously. The demands of this type of electrical test and analysis mean that a large amount of data must be transferred quickly from your Voltech Analyser to the host PC. Under certain unusual circumstances, mostly dependant upon the performance of the host PC, the flow of test data may be momentarily interrupted by other programs making demands upon the system. This will lead to computational errors and therefore a test failed error message will be displayed.

To avoid any such possible problems, Voltech strongly recommends that you take the following normal precautions:

1. All other applications should be closed or at least be inactive while a test is running. If the programs are left running but not used, features such as 'Auto-save' should be disabled.
2. System features that may interrupt normal operation such as screen savers, battery management (laptops) and the Windows '95 'system agent' should be disabled.
3. Networking 'shares' should be disabled or remain inactive. A network user accessing the PCs' local disk or printer may interrupt communications.
4. Do not use the host PC for any type of shared printer.
5. Disable any internal modem that has auto-answer features.

3.2. IEEE 488 INTERFACE CARDS SUPPORTED

- IOtech Personal 488 (GP488B)
- National Instruments GPIBII/IIA
- CEC 488
- Most other standard types

Note that while the software supports IEEE 488 cards, this is currently only for the control of an AC source. The PM6000 does not currently support an IEEE 488 interface.

3.3. POWER ANALYZERS SUPPORTED

Voltech model numbers: PM6000 with firmware Version 1.08.01 or above. The Firmware version can be found by selecting the System menu followed by the Configuration menu and then selecting "View Hardware". Please contact Voltech or your local agent should you require a firmware upgrade.

3.4. INSTALLING THE SOFTWARE TO YOUR PC

Your software will have been supplied on a CD-ROM or electronically via email or website download.

To install the software:

- If the software was supplied on CD-ROM, run the “IEC61000 Software for PM6000.exe” file in “<drive>\PM6000 Information\IEC Harmonics & Flicker Software” to install the software. If the software was provided electronically, the run “IEC61000 Software for PM6000.exe”
- Follow the on screen instructions.

The default directory for the IEC61000-3 for Windows software is C:\Program Files\Voltech Instruments\Voltech IEC 61000 Software for PM6000. You may choose an alternative drive / directory, when prompted during the installation process.

A copy of this user manual can also be found in the “<drive>\PM6000 Information\IEC Harmonics & Flicker Software” directory.

3.5. REGISTERING THE SOFTWARE

The software is supplied to you under the terms of our current license agreement and is for use on a single PC only. As supplied, the software will not communicate with a Power Analyzer until it has been registered. (You may however browse and print the example results supplied before the software is registered.

To register the software,

- Install the software on the PC where it is intended to be used (as above).
- Look at the registration details found under 'Registration' from the 'Help' menu. This dialogue will display an 'ID Code', which is unique to that PC installation. (Select 'Register' if no ID code is shown)

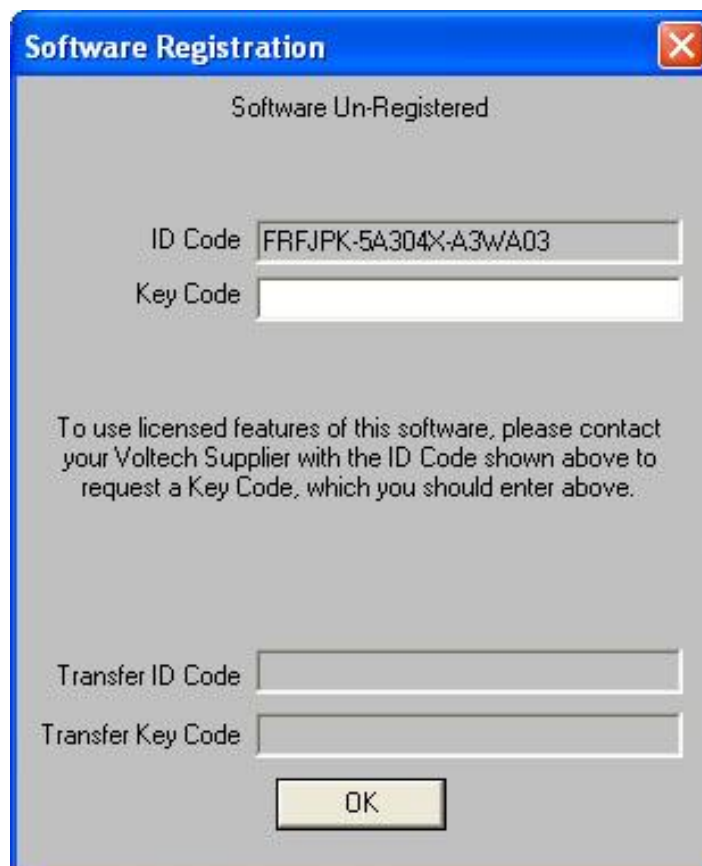

- Contact your Voltech supplier with the exact 'ID Code' and you will be issued with a 'Key Code' provided that the appropriate payment has been received. (It is also possible to provide a 'Demo' key code at no charge, which will fully enable the software for 30 days only).
- Open the 'Registration' dialogue as above and enter the 'Key Code'.
The software will now operate.

The 'Key Code' (demo or full version) is not time related and may be entered at any time after you have sent the 'ID Code' to Voltech.

3.6. TRANSFERRING THE SOFTWARE TO A DIFFERENT PC

The software is licensed for use on one PC only. At Voltech's discretion it is possible to occasionally transfer the licence to a different PC.

To transfer the licence:

- Install a copy of the software on the new PC.
- Enter the ID code given on the new PC in to the Transfer ID box on the old PC. This will disable the software on the old PC.
- Take the Transfer Key Code from the old PC and enter it in to the Key Code on the new PC.

3.7. SETTING UP YOUR IEEE488 INTERFACE CARD

Refer to the user manual supplied with your IEEE488 interface card for the recommended procedures for installation and set-up of the card in your PC. If there is any difficulty, the following brief notes may be of help.

NOTE: The PM6000 does not current have an IEEE 488 interface.

IOtech Personal 488

- Make sure that the card has been supplied with a software disk containing the following device driver:

Driver488/NI

- Before installing the Personal 488 card into your PC, make a note of the following:

Type of card: GP488B

IRQ level: Set by jumpers on the card - factory default setting = 7

DMA channel: Set by jumpers on the card - factory default setting = 1

Memory address: Set by switches on the card - factory default setting = 02E1

- Switch off the PC, and follow the instructions given in your IOtech user manual to install the interface card.
- Switch on the PC and start Windows.
- Install the interface card driver software:
- Insert the disk labelled 'Driver488/NI' into drive A
- From the Windows Program Manager, using the mouse

Pull down the File menu

Click on Run

- In the Run dialogue box, on the Command Line type

A:\WINDOWS\SETUP

and click on the OK button

Enter the configuration of the interface card:

- Use Windows File Manager to select the and run the file

C:\WINDOWS\IEEE488\CONFIG.EXE

(This assumes that you allowed the SETUP program above to use the IOtech default directory - C:\WINDOWS\IEEE488.)

- On the CONFIG display screen, set up the interface card details noted above.
- Use the Windows File Manager to copy the file GPIB.DLL from C:\WINDOWS\IEEE488 to C:\WINDOWS\SYSTEM.
- Again using Windows File Manager, select the and run the file C:\WINDOWS\IEEE488\DRVR488W.EXE
- You can now run the IEC61000-3 for Windows Software.

Between runs of the IEC61000-3 for Windows Software, it is recommended that you exit from and close down Windows, and then start Windows again to reset the IOtech drivers, before re-starting the IEC61000-3 Software.

Note:

If you find difficulty in getting the IOtech card to operate, it may be necessary to install the virtual DMA driver supplied with the card:

- Using Windows Notepad, open the file C:\WINDOWS\SYSTEM.INI
- Find the line containing the string 'vdmad', and comment it out by placing a semicolon at the beginning of the line.

- Immediately below this line, insert the new line
DEVICE=C:\WINDOWS\IEEE488\VDMAD.386
- Save the file and re-start Windows.

National Instruments GPIBII/IIA

- Switch off the PC, and follow the instructions given in your National Instruments user manual to install the interface card.
- Switch on the PC and start Windows.
- Install the interface card driver software:
 - Insert the National Instruments Driver Disk (1 of 2) into drive A
 - From the Windows Program Manager, using the mouse
 - Pull down the File menu
 - Click on Run
 - In the Run dialogue box, on the Command Line type
A:\SETUP
and click on the OK button
- After the 'setup' program has finished, you can run the IEC61000-3 for Windows Software.

CEC 488

- Switch off the PC, and follow the instructions given in your CEC user manual to install the interface card.
- Switch on the PC and start Windows.
- Use the Windows File Manager to copy the file GPIB.DLL from
A:\CECDRIVE to C:\WINDOWS\SYSTEM.
- After the copy has finished, you can run the IEC61000-3 for Windows Software.

4. GETTING STARTED

4.1. STARTING THE SOFTWARE

Installing software will create a program shortcut in the 'Voltech Software' program group. Click on IEC 61000 Software for PM6000' to start the software.

4.2. SETTING UP THE TEST EQUIPMENT

To test products to IEC61000-3, you will probably set up a test rig similar to the one shown below.

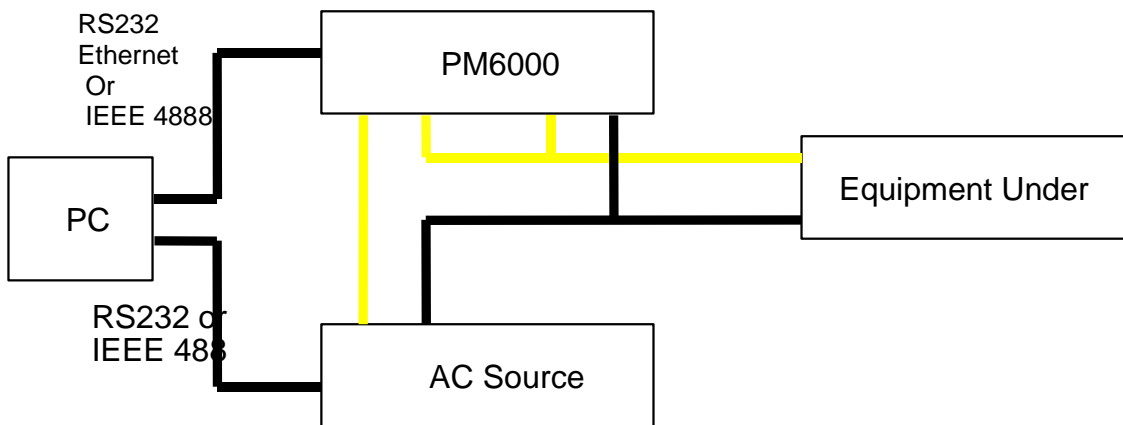

In many cases, you will be able to use a single test rig for the evaluation of a number of different products to the IEC61000-3 specification. Therefore, the IEC61000-3 software has a 'Setup' menu, which allows you to configure the test equipment and the type of test to perform first.

PC to PM6000 Connections

To communicate between the PC and the PM6000, RS232, Ethernet or IEEE 488 communications can be used. If you are using IEEE 488 communications, you will need an RS232 to GPIB converter. One example is the National Instruments GPIB-232CV-A that has been reliably used with the PM6000 at 38400 baud.

If you are using RS232 as the communications method, then you will be a 9 way female to 9 way female Null Modem cable.

For either method of communications the baud rate of the PM6000 need to be set up, along with other options. To set the baud rate, press “Interface” on the PM6000 and the select “Serial” followed by “RS232” followed by baud rate. When selecting the baud rate, then minimum for IEC61000 communications is 38400.

After selecting the baud rate, you will also need to turn on the Echo feature. This is done from the RS232 options menu.

PM6000 to Equipment Under Test Connections

The PM6000 needs to be connected to the equipment under test to measure both the voltage and the current. Even for fluctuating harmonics testing, which is a current measurement, the voltage source is measured.

One easy way to connect break the conductor carrying the power to the equipment under test is to use one of Voltech’s Break Out boxes. They come with a variety of different outlet types and provide an easy way to connect your equipment under test while making easy connections for voltage and current.

4.3. SET-UP POWER ANALYZER AND AC SOURCE COMMUNICATIONS

From the Top Level menu select (using the mouse),

Setup

Communications

Power Analyzer

to bring up the following dialogue box:



If you are using an IEEE488 interface, then enter the address of the Power Analyzer, and click on the OK button.

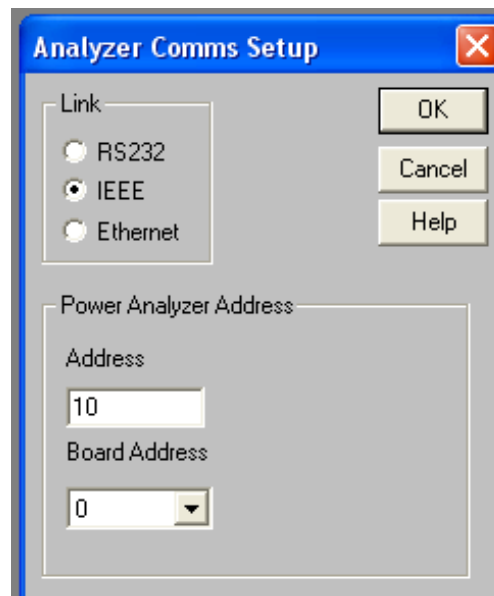

Alternatively, if you are using a serial interface, click with the mouse on the RS232 button, enter the appropriate Comm Port and Baud Rate, and then click the OK button. The baud rate must match the baud rate set up on the PM6000. 38400 baud is the minimum.

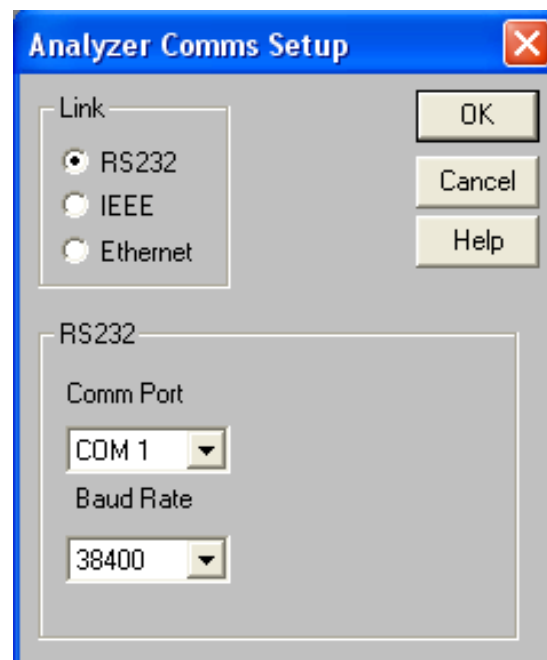

If you are using an Ethernet interface, click with the mouse on the Ethernet button, enter the appropriate IP Address and then click the OK button.

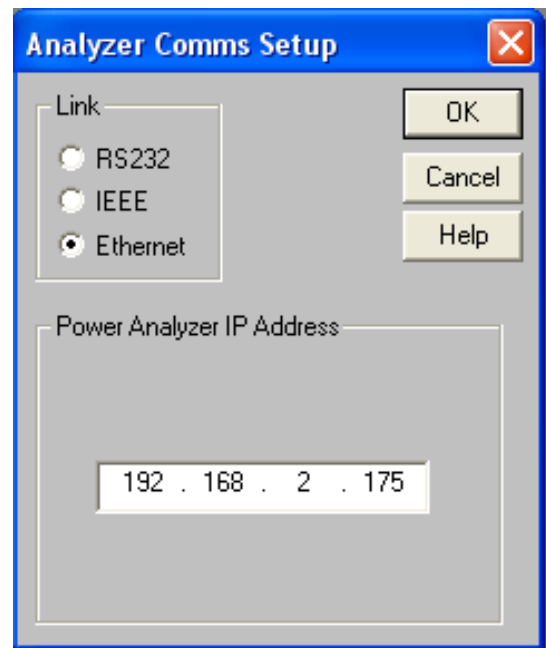

Having set up the communications interface for the Power Analyzer, clicking OK will return you to the Top Level menu. (This obviously would not be necessary if you were using the available mains supply instead of a programmable ac source.)

4.4. SETUP AC SOURCE

(This stage is not necessary if you were using the available ac supply instead of a programmable ac source or a manually controlled source).

Again from the Top Level menu, using the mouse, select

Setup

AC Source

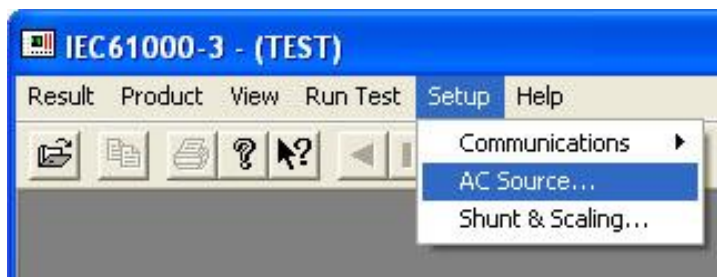

At the next dialogue box,

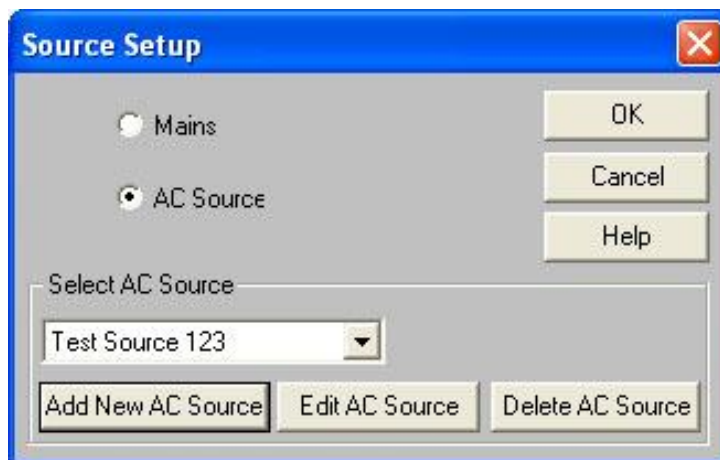

you can choose to have the software automatically control an AC Source or to use the normal line supply ('Mains') / manually controlled source.

Using the normal mains (AC line) supply or manually controlling an AC Source

Select 'Mains' (AC line) and click on 'OK'. The software will prompt for AC Source ON and OFF during testing.

Automatic control of a programmable AC Source

The software can also automatically control an AC Source that has a suitable RS232 or IEEE interface (See above). Under automatic control the software will set the AC source output ON and OFF to the desired voltage and frequency during testing.

If the AC source model you are using is listed simply select it and click on 'OK'.

To configure an AC Source that is not listed, select 'Add New AC Source'.

To edit the details of an existing source, select the source and then choose 'Edit AC Source'.

For both of the above, you will see the same Configure AC Source dialogue.

To delete a source, first select it and then choose 'Delete AC Source'

Configuring an AC Source

Setup User Source

User Configurable Power Source

Name:

Commands

Power 'on' command:

Power 'off' command: Prompt for on/off

Frequency command:

Voltage	Voltage Command	Range Command	Impedance Command
<input type="text" value="230"/>	<input type="text" value=":VLT:230"/>	<input type="text" value=":RNG:1"/>	<input type="text"/>
<input type="text"/>	<input type="text"/>	<input type="text"/>	<input type="text"/>
<input type="text"/>	<input type="text"/>	<input type="text"/>	<input type="text"/>
<input type="text"/>	<input type="text"/>	<input type="text"/>	<input type="text"/>

Command delay: ms

OK Cancel

Name

Identifies your AC Source. Manufacturer and model number should be entered.

Commands

Enter here the AC Source commands that should be issued by the software to turn the source output on and off during testing and to set up the frequency of the source (usually 50Hz).

Voltages

Enter here the voltages at which you wish to test and their respective AC source commands. Normally only 230V is necessary.

Range and output impedance commands may be required to set some sources up correctly.

Source command delay

Enter here a time in milliseconds if you are experiencing communications problems. It is possible for the software to issue consecutive commands before a source is ready for them. If in doubt, start with a long delay (1000mS) and shorten the delay if required.

Source ON OFF prompt

By default this box is not checked and the software will automatically turn the source off and on when required. If this box is checked, the software will prompt for confirmation that you want the source turned off at the end of the test. In this way the source can be left on permanently.

4.5. POWER ANALYZER SHUNT AND SCALING

Normally, you would make all the measurements using the current and voltage ranges of the Power Analyzer directly. It is possible to use the analyzer with external voltage or current transducers to extend the measurement range.

From the Top Level menu, using the mouse, select

Setup

Shunt & Scaling

to bring up the following dialogue box:

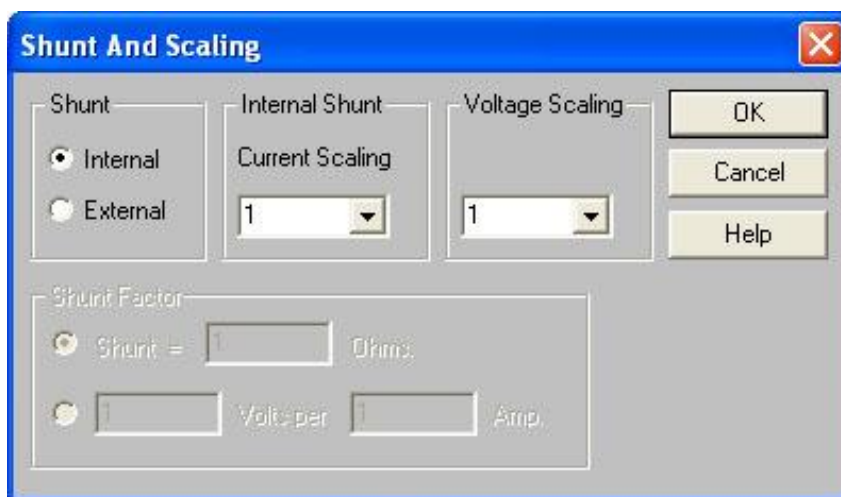

If the transformer is not 1:1, you should enter the appropriate current (or voltage) scaling factor before clicking on OK.

If you are using a current shunt external to the Power Analyzer, then select the External button,

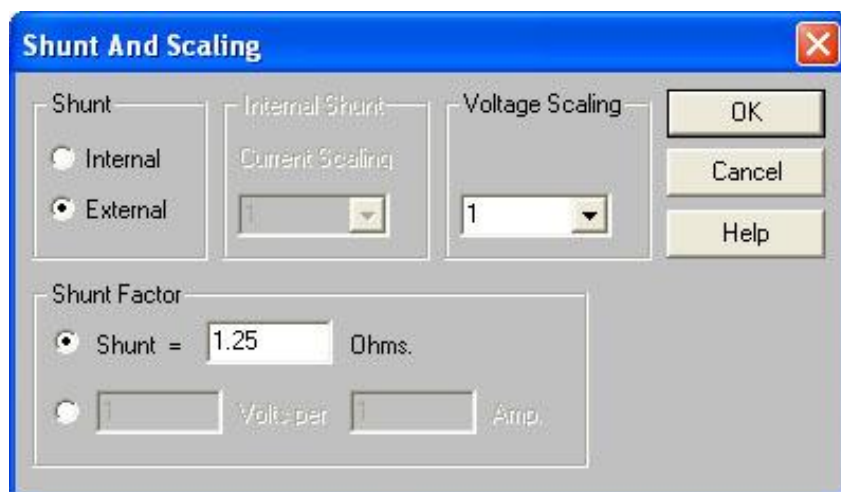

and enter the value of the shunt in the Shunt Factor section at the bottom of the dialogue box. Note that you may enter either an Ohmic value by selecting the upper button as shown in the display above, or a Volts per Amp ratio by clicking on the lower button.

When all the data is entered, click on the OK button to return to the Top Level menu.

Note: Do not direct adjust the PM6000 shunt and scaling from the PM6000 front panel.

4.6. ENTERING A NEW PRODUCT

The IEC61000-3 Standard is concerned with the testing and certification of products. Therefore, to enable you to set up and run a program of tests for each product, the IEC61000-3 software organises its results files identified by the name of the product under test.

The first task for you to do when starting a series of tests on a new product is to enter the data for that product. Let us assume that the particular new product is a Power supply called *PS123*.

To enter the new product *PS123*:

From the Top Level menu select (using the mouse),

Product

New

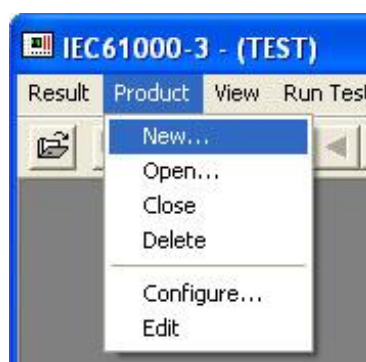

to bring up the Product Description dialogue box.



Using the mouse to move between the various fields, enter the data for the following:

- Product Title (in this case *PS123*) - using a maximum of 20 characters
- The product Description - a maximum of 120 characters
- The Serial Number - a maximum of 20 characters
- The working Drive and Directory where the data is to be stored (If required, use the Network button to access more drives connected to your network.)

For the Description and the Serial Number, you can use any of the keyboard characters in any order, including both upper and lower case alpha-characters. Similarly, for the Title, you can again use any of the keyboard characters in any order, but alpha-characters are restricted to upper case only.

Having entered the required data, click on the OK button, to move to the next dialogue box:

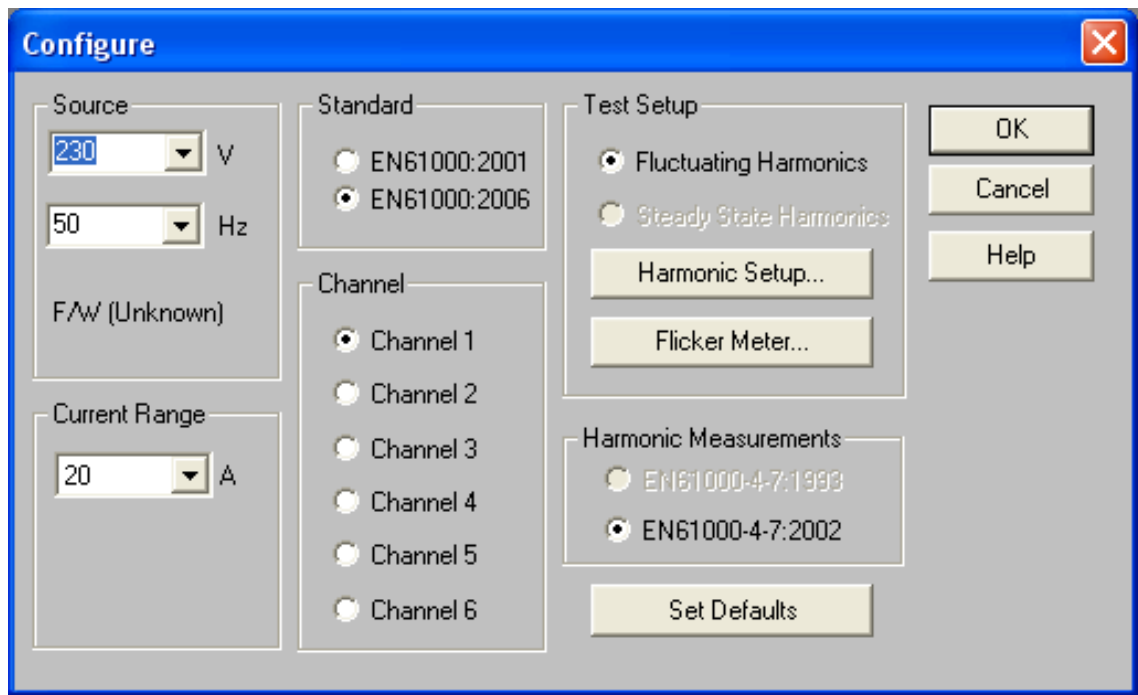

Again using the mouse to move between the various fields, set up the following:

- The Operating Voltage (230V)
- The Current Range (1A)
- Which Channel of the PM6000 will be used for measurement (Channels 1 through 6).

(The data in parenthesis are the values chosen in the case of *PS123*)

Please note that although you can specify testing at 120V, 60Hz, the tests results are not valid for compliance testing of flicker measurements. 120V, 60Hz testing is detailed in the measurement techniques document for flicker (IEC 61000-4-15), it is not a requirement of the flicker testing standard (IEC 61000-3-3).

4.7. CONFIGURING A FLUCTUATING HARMONICS TEST

From the product configuration dialogue (above), click on 'Harmonic Setup...'

The screenshot shows the 'Set Fluctuating Harmonics' dialog box. It features a blue title bar with the text 'Set Fluctuating Harmonics' and a close button. The main area is divided into two sections. The top section is labeled 'Class' and contains four radio buttons: Class A (selected), Class B, Class C, and Class D. A dropdown menu next to Class C shows '> 25W'. To the right of the class selection are three buttons: OK, Cancel, and Help. The bottom section contains several input fields: 'Minimum Power' (75 Watts), 'Specified Power' (0 Watts), 'Fundamental Current' (0 Amps), 'Power Factor' (0), 'Class Multiplier' (1), and 'Test Duration' (2:30 mm:ss). At the bottom, there is a checkbox for 'Display notes on reports' which is checked.

Select the Class (A, B, C or D) that the equipment belongs to. (See Chapter 2.) The correct limits will automatically be chosen. The other possible entries into this dialogue are described below.

Once the dialogue entries are complete, click on 'Ok' and close the product configuration dialogue. The 'product' is now ready to test.

Class C Limits

There are three possible types of limit that can be applied to Class C of equipment.

Class C >25W

Uses the limits described in Chapter 2.

Note that for this test, the fundamental input current and power factor must be known and entered in to the test detail dialogue since these values are used to calculate the limits. The analyzer automatically measures fundamental input current and power factor in accordance with the required measurement methods and displays the result. The measured fundamental input current and power factor can then be entered retrospectively and the limits re-computed.

Class C less or equal to 25 W

There are 2 possible limits that may be applied:

1. The Class D limits.

OR

2. The limits below as long as the current waveform meets certain criteria for its shape. Note that these criteria are completely different to the waveform shape checking used for Class D in a previous edition of the standard.

The waveform shall be such that it reaches the 5% current threshold before or at 60 degrees, has its last peak (if there are several peaks per half period) before or at 65 degrees and does not fall below the 5% threshold before 90 degrees, where the zero crossing of the fundamental supply voltage is assumed to be at 0 degree. The 5% threshold is determined by the highest absolute peak value of the current waveform that occurs during the measurement window.

Class C <25W 'Waveform' limits.

The maximum permissible harmonic currents expressed as a percentage of the input current at the fundamental frequency are:

3rd 86 %

5th 61 %

Minimum Power

This is the power level specified by the standard, below which no limits apply. (Except for lighting equipment. When Class C is selected this field is inactive).

Specified Power

The power of the equipment under test as specified by the 'manufacturer'.

The specified power is used to calculate limits for Class D and some Class C tests. This field is inactive when Class A or Class B is selected.

The power must be determined using the methods detailed below. If the power is unknown, it will be measured by the analyzer and this value can be entered retrospectively at the end of the tests and the limits re-computed accordingly.

(from 6.2.2 of the standard.....)

The value of input power to be used for calculation of limits shall be determined as follows:

- measure the 1.5s smoothed active input power in each DFT time window;
- determine the maximum of the measured values of power from the DFT time windows over the entire duration of the test.

The value for power, measured as defined in this clause, shall be specified by the manufacturer and documented in the test report. This value shall be used for establishing limits during emissions tests when limits are specified in terms of power. In order not to specify a power at which limits change abruptly, thus giving rise to doubt as to which limits apply, the manufacturer may specify any value which is within 10% of the actual measured value.

The value for power found by measurement during emission tests other than the original manufacturer's conformity test, measured according to the terms of this clause, shall not be less than 90% nor greater than 110% of the value for power specified by the manufacturer. In the event that the measured value is outside of this tolerance band about the specified value, the measured power shall be used to establish limits.

Fundamental Current

The fundamental current is used to calculate some Class C limits. This field is inactive when Class A, B or D is selected.

The fundamental input current is defined to be the maximum of the measured values of 1st harmonic current from the DFT time windows over the entire duration of the test.

If the fundamental current is unknown, it will be measured by the analyzer and this value can be entered retrospectively at the end of the tests and the limits re-computed accordingly.

Power Factor

The power factor is used to calculate some Class C limits. This field is inactive when Class A, B or D is selected.

The power factor is defined to be the ratio of volt-amperes to watts obtained from the same DFT measurement window as the value for the fundamental component of current.

If the power factor is unknown, it will be measured by the analyzer and this value can be entered retrospectively at the end of the tests and the limits re-computed accordingly.

4.8. PERFORMING A HARMONICS TEST

Once the test has been configured, choose 'Fluctuating Harmonics' from the 'Run Test' menu:



and the software will automatically configure the analyzer and AC Source. (For a manual source, you will be prompted to 'Switch the Mains on Now'. Once the system is ready, you will see the following dialogue:



Click on 'Start' to begin the test.

In accordance with the standards, the first 10 seconds of the test will be ignored. The equipment under test should be switched on or - depending on the equipment behaviour- before the time that you click start.



After this ten-second period, the PC will display the latest harmonics reading in real time.

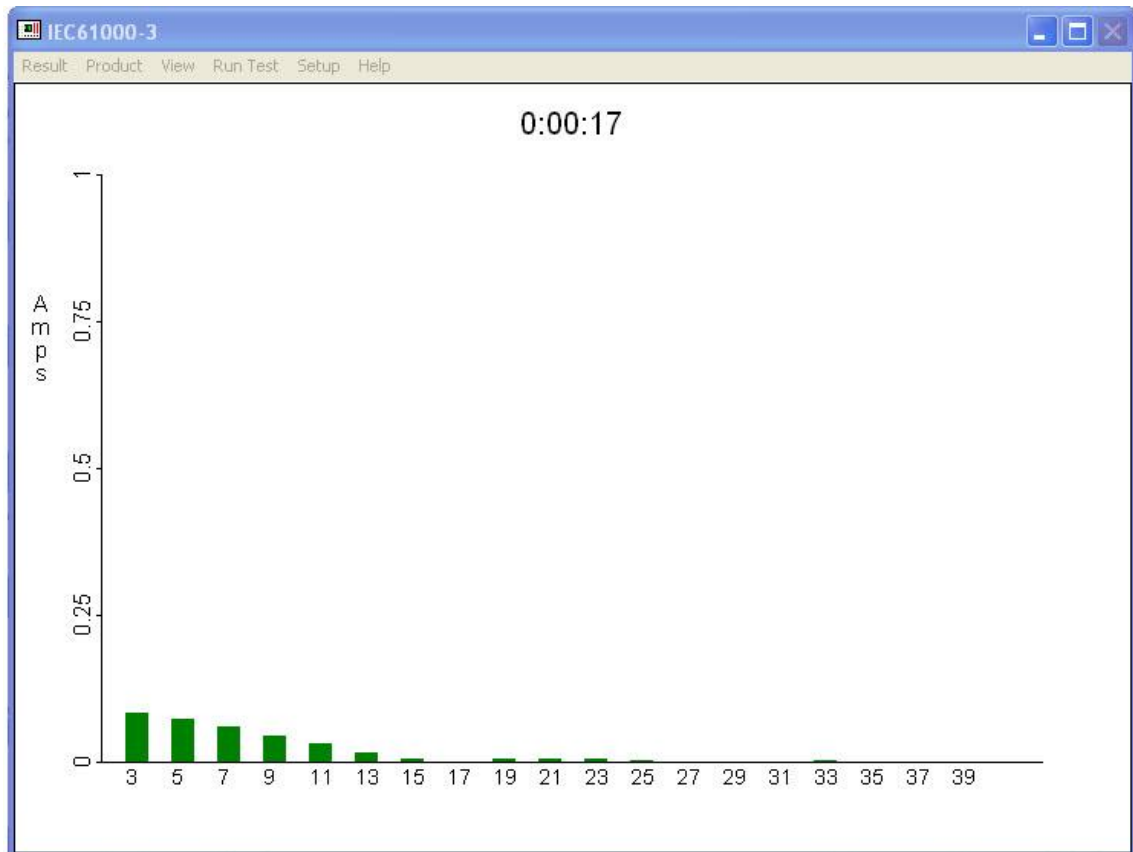

At the end of the test the software will automatically reset the analyzer and AC Source. (If you are using a manual AC Source you will be prompted to switch it off)

You must then save the results using the filename and directory of your choice.

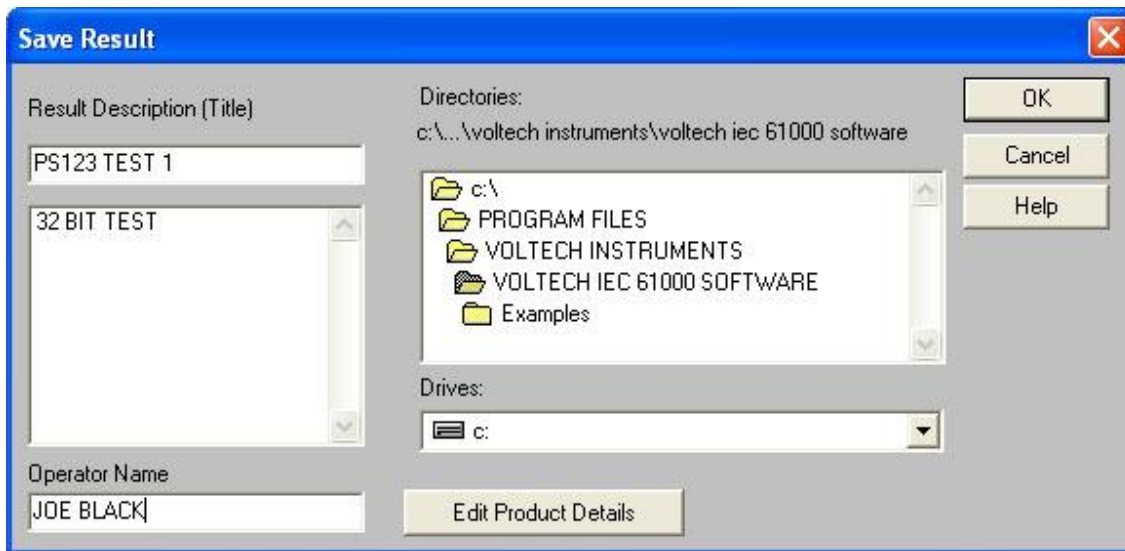

You may also choose to enter an operator name at this point.

Notice also that you may 'Edit Product Details' which allows you to change the:

- Product Title
- Serial Number and
- Description

From those originally entered when the product was configured.

You will then be presented with a summary of the test results. See the next section for a description of the possible result views for fluctuating harmonics.

4.9. CHANGING TEST DETAILS

When a fluctuating harmonics result is open (see below) the test details (Class limit and user entered data) may be changed at any time by selecting 'Result', 'Change Test Details...'

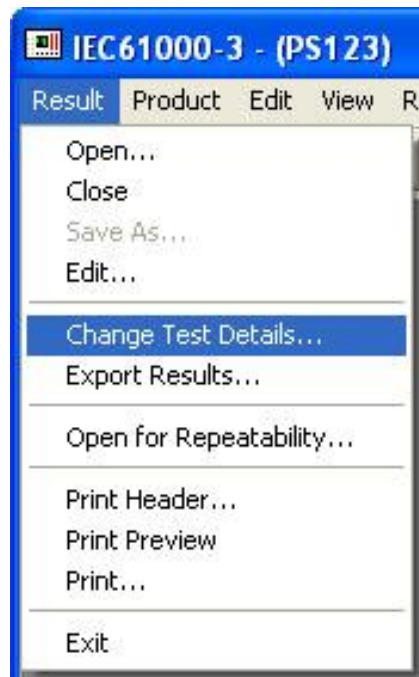

This allows the measurements for any fluctuating harmonics test to be re-classified and compared against revised limits and saves you from having to make pre-tests to determine, for example, maximum watts.

4.10. VIEWING RESULTS

At the end of a test or by opening a result several different result and diagnostic views are available.

To open a previously saved result, select 'Result', 'Open' to see this dialogue:

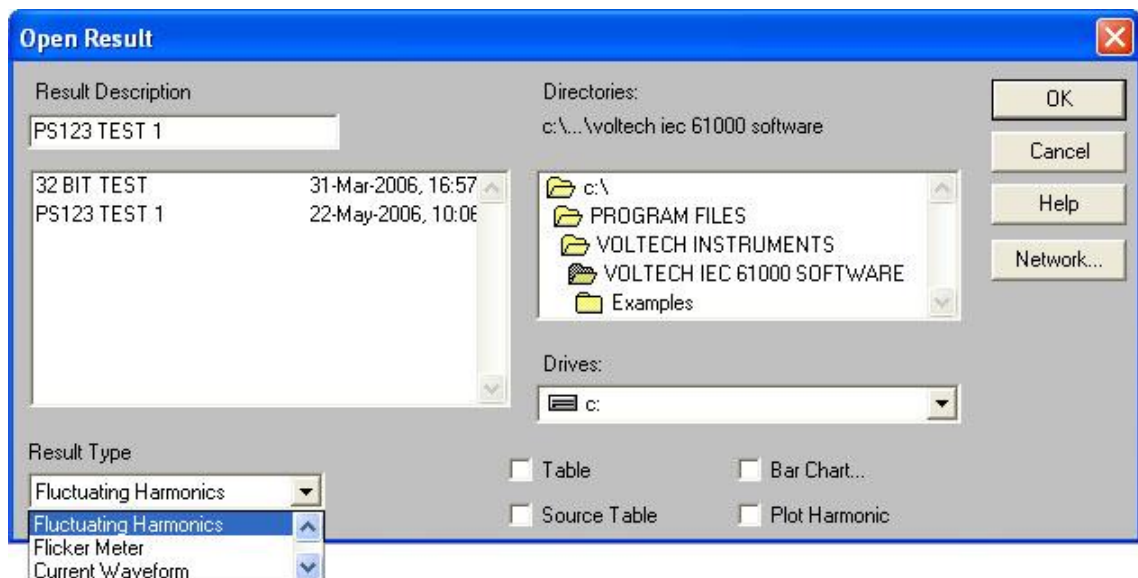

Select the 'Result Type' ('Fluctuating Harmonics' in this example), locate the result you wish to open and double click on it.

4.11. VIEWING FLUCTUATING HARMONICS RESULTS

The default view that is opened is the 'Summary Results' view. The views available below the 'View' menu are described below.

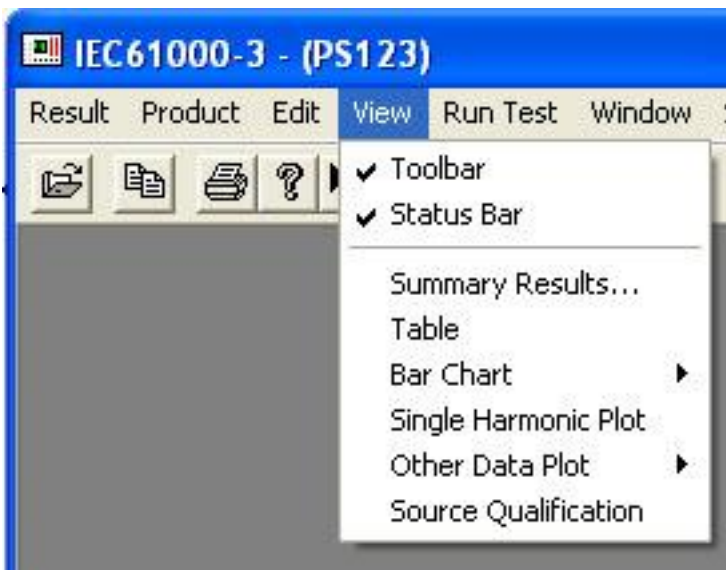

Summary Results

SELF-TEST - Fluctuating : Summary Results Table (2001)		
Product: HELP EXAMPLE		
Serial no: 1234		
Description: You can edit the details at any time.		
Test Date: 27 Feb 2001 19:04		
Result Name: SELF-TEST		
Type of Test: EN61000:2001 Harmonics		
Limits: Class D		
Power Analyzer: Voltech PM3000A v2.17 s/n 2073		
AC Source: Mains / Manual Source		
Overall Result:	Notes:	
FAIL	Current harmonic > limit 2 Supply Voltage outside permitted limits Crest Factor outside permitted limits Voltage Harmonics outside permitted limits Scaling Limits not 1 Specified power not equal to measured	
Test Parameter Details	User Entered	Measured
Operating Frequency:	50	49.9082
Operating Voltage:	230	239.2000
Specified Power:	100.0000	302.6328
Fundamental Current:	0.0000	1.3985
Power Factor:	0.0000	0.8098
Average Input Current:		0.0000

IEC61000-3 - [TEST 3 21-08-07 - Fluctuating : Summary Results Table (2006)]		
Result Product Edit View Run Test Window Setup Help		
Product: IEC 61000-3-2:2006		
Serial no: 1-05-02 RC4		
Description: IEC 61000-3-2:2006 Limit Check		
Test Date: 21 Aug 2007 14:02		
Result Name: TEST 3 21-08-07		
Type of Test: EN61000:2006 Harmonics inc. interharmonics to EN61000-4-7		
Limits: Class A		
Power Analyzer: Voltech PM6000 v1.13.05RC1 s/n 100006700004		
AC Source: Mains / Manual Source		
Harmonic Results	Notes:	
Against Chosen Limits:	Failed 10%/10min time window Scaling Limits not 1	
FAIL		
Test Parameter Details	User Entered	Measured
Operating Frequency:	50	49.9840
Operating Voltage:	230	233.9807
Specified Power:	0.0000	3130.0232

This is a summary test report showing the overall test PASS / FAIL together with all the product and test details.

The first 3 sections of this report will automatically appear at the top of the printout of any of the other result views available.

Table

The table results show the average harmonic readings and the maximum individual smoothed harmonic readings compared to the limits.

Harmonic	Limit 1	Limit 2	Average Reading	<L1 <L2	Max Reading	<L2	Pass/FAIL
3	340.0mA	510.0mA	570.9mA	* *	606.3mA	*	Fail
5	190.0mA	285.0mA	210.6mA	* ✓	211.7mA	✓	Fail
7	100.0mA	150.0mA	95.16mA	✓ ✓	103.7mA	✓	Pass
9	50.00mA	75.00mA	82.86mA	* *	84.40mA	*	Fail
11	35.00mA	52.50mA	27.24mA	✓ ✓	31.99mA	✓	Pass
13	29.61mA	44.42mA	30.14mA	* ✓	31.30mA	✓	Fail
15	25.66mA	38.50mA	16.06mA	✓ ✓	19.57mA	✓	Pass
17	22.64mA	33.97mA	14.07mA	✓ ✓	15.05mA	✓	Pass
19	20.26mA	30.39mA	11.12mA	✓ ✓	11.59mA	✓	Pass
21	18.33mA	27.50mA	8.119mA	✓ ✓	8.431mA	✓	Pass
23	16.73mA	25.10mA	7.335mA	✓ ✓	8.008mA	✓	Pass

In the example above, the results for harmonic 5 show that the average result has exceeded limit 1 but not limit 2 and that the maximum reading has not exceeded limit 2 resulting in a FAIL for harmonic 5. See the reference information for more details.

Harmonic	Limit 1	Limit 2	Average Reading	<L1 <L2	Max Reading	<L2	Pass/FAIL
2	1.0800A	1.6200A	7.293mA	✓ ✓	139.0mA	✓	N/A
3	2.3000A	3.4500A	2.0415A	✓ ✓	3.9282A	*	Pass
4	430.0mA	645.0mA	6.095mA	✓ ✓	108.9mA	✓	N/A
5	1.1400A	1.7100A	4.542mA	✓ ✓	42.84mA	✓	N/A
6	300.0mA	450.0mA	1.981mA	✓ ✓	31.88mA	✓	N/A
7	770.0mA	1.1550A	2.718mA	✓ ✓	43.74mA	✓	N/A
8	230.0mA	345.0mA	1.657mA	✓ ✓	35.97mA	✓	N/A
9	400.0mA	600.0mA	1.478mA	✓ ✓	19.77mA	✓	N/A
10	184.0mA	276.0mA	1.173mA	✓ ✓	19.76mA	✓	N/A
11	330.0mA	495.0mA	1.991mA	✓ ✓	27.05mA	✓	N/A
12	153.3mA	230.0mA	1.008mA	✓ ✓	23.18mA	✓	N/A
13	210.0mA	315.0mA	1.068mA	✓ ✓	12.21mA	✓	N/A
14	131.4mA	197.1mA	1.274mA	✓ ✓	15.76mA	✓	N/A
15	150.0mA	225.0mA	1.821mA	✓ ✓	20.86mA	✓	N/A
16	115.0mA	172.5mA	1.134mA	✓ ✓	16.27mA	✓	N/A
17	132.3mA	198.5mA	1.183mA	✓ ✓	8.504mA	✓	N/A
18	102.2mA	153.3mA	0.819mA	✓ ✓	13.38mA	✓	N/A
19	118.4mA	177.6mA	1.486mA	✓ ✓	17.16mA	✓	N/A
20	92.00mA	138.0mA	0.585mA	✓ ✓	10.99mA	✓	N/A
21	107.1mA	160.7mA	0.870mA	✓ ✓	7.622mA	✓	N/A
22	83.63mA	125.4mA	0.657mA	✓ ✓	12.53mA	✓	N/A
23	97.82mA	146.7mA	0.962mA	✓ ✓	13.22mA	✓	N/A
24	76.66mA	115.0mA	1.042mA	✓ ✓	8.158mA	✓	N/A
25	90.00mA	135.0mA	1.157mA	✓ ✓	7.326mA	✓	N/A

In the example above the harmonic 3 has exceeded L2 (150% limit) but the average value has not exceeded 90% of the applicable limit resulting in a PASS

Bar Charts

Four types are available. Each displays 40 harmonics along the bottom with a bar above representing the amplitude of the harmonic.

Linear Worst Case

Shows the maximum amplitude of each of the individual smoothed harmonics.

Average Vs Limit 1

Shows the average value of each harmonic compared to Limit 1. A red bar indicates a failure.

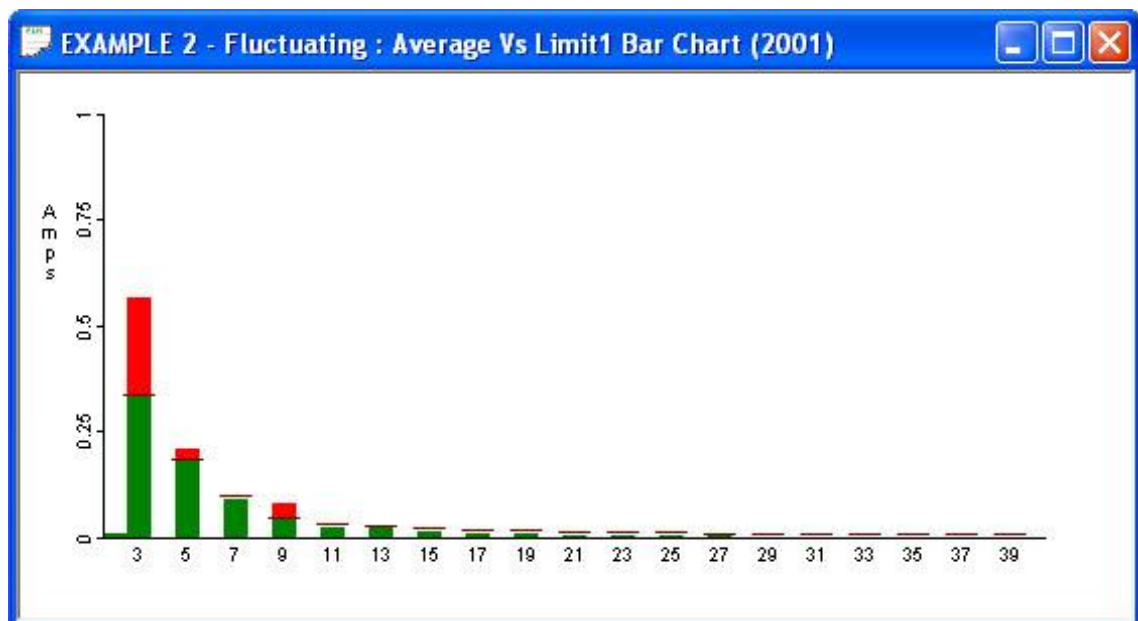

Normalized Worst Case

The normalised worst-case bar chart shows the highest values for the individual smoothed harmonics during the test compared to their limit. The data is the same as that presented in the 'Linear Worst Case' view, but in this 'Normalized' view, Limit 1 is scaled to equal 1 and the same scale factor is used to display Limit 2 and the worst case harmonic. This view shows how close a harmonic is to its limit, irrespective of the size of the limit.

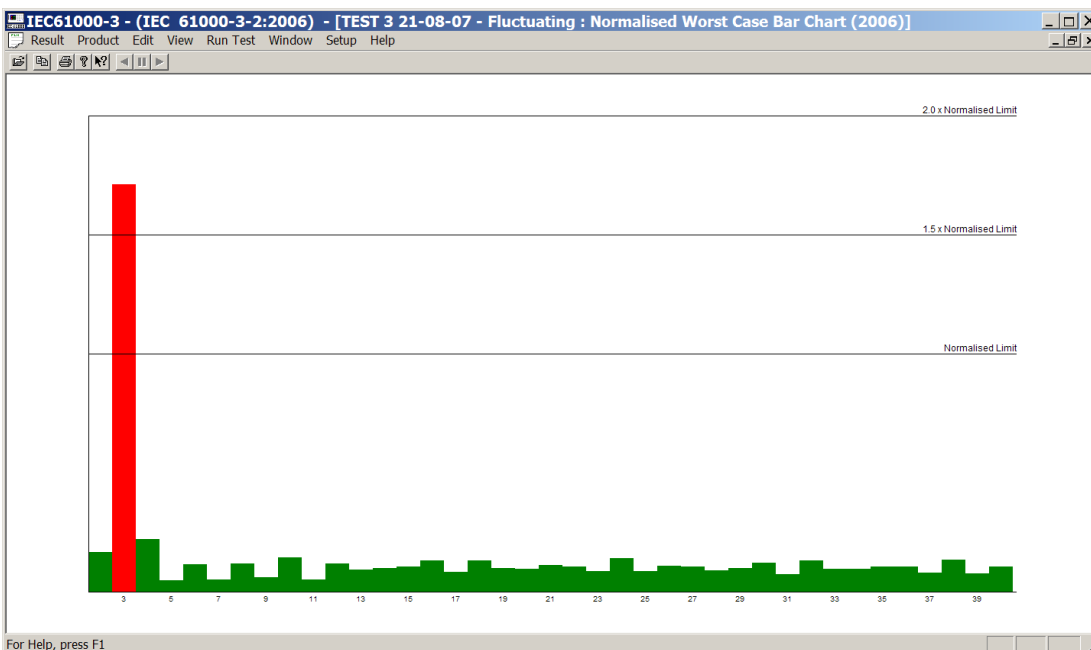
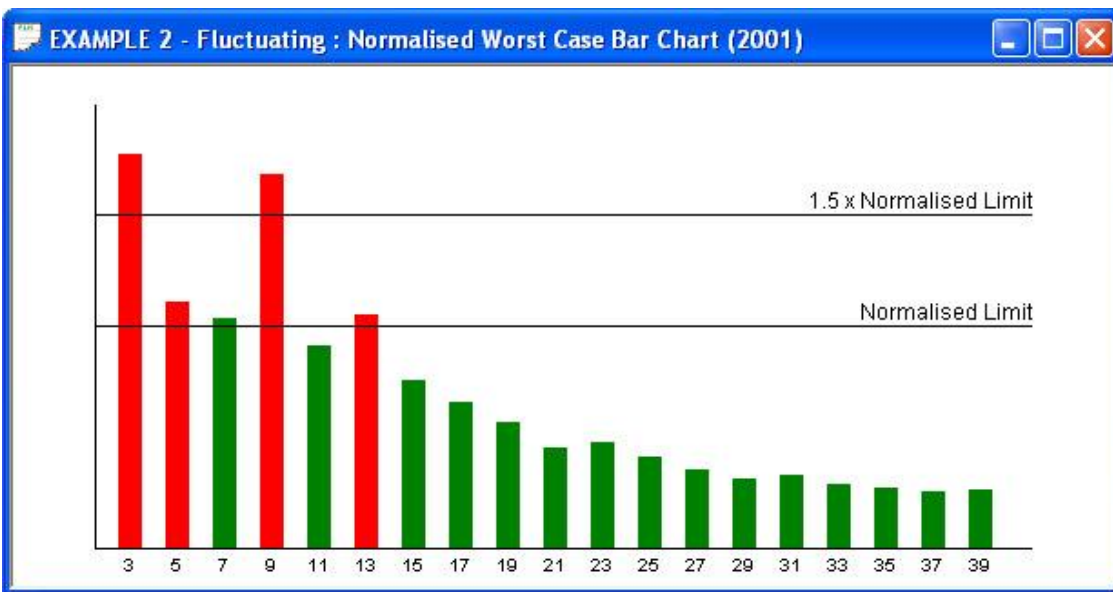

Linear All

In this view the level of the individual harmonics are shown for each 10 cycle (200ms@ 50Hz) are shown together with limits 1 and 2.

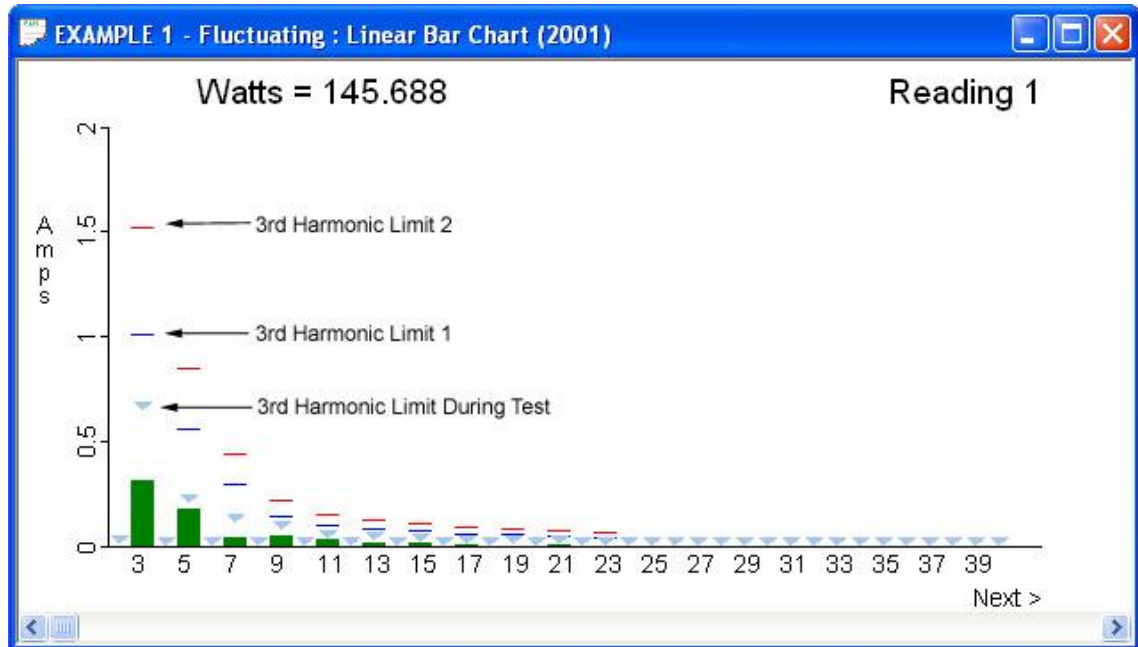

Use the play and pause keys to scan through each reading automatically or use the < and > keys of the keyboard to scan through the readings one at a time.



Normalized All

This view shows each of the 10 cycle block readings (as above) with the limits normalised. This view shows how close a harmonic is to its limit, irrespective of the size of the limit.

Single Harmonic Plot

In this view the time (in seconds) is shown on the bottom axis. The plot is of the amplitude of the selected harmonic during the duration of the test.

Limit 1 and Limit 2 (and Limit 3 2006)for that harmonic are also shown.

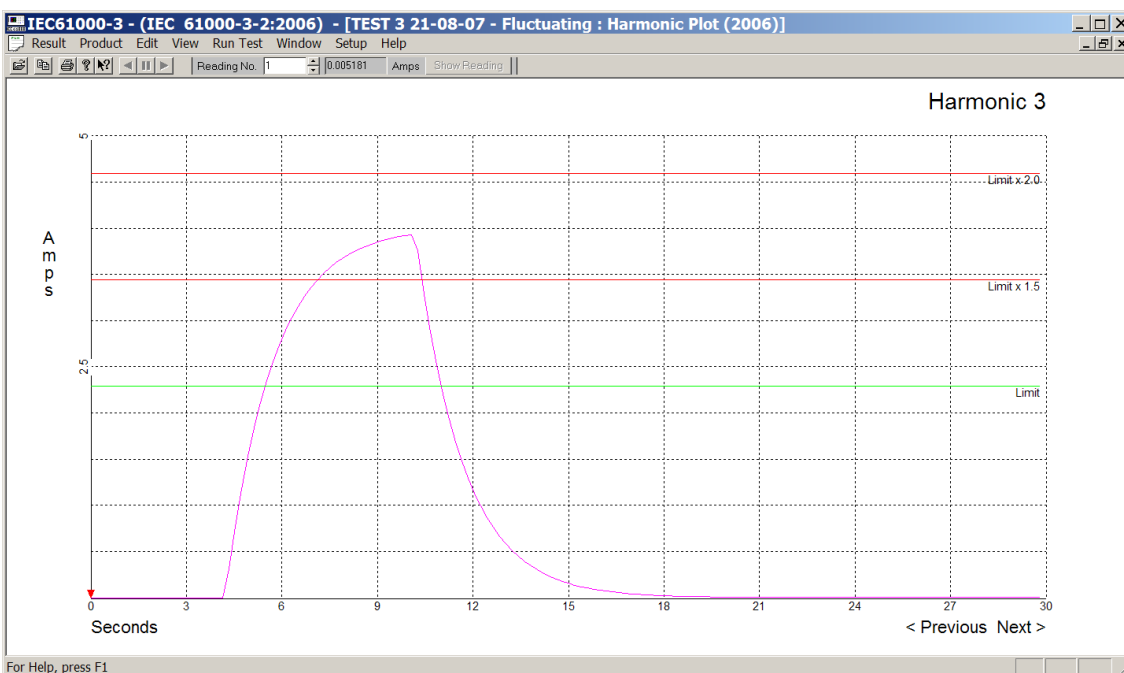
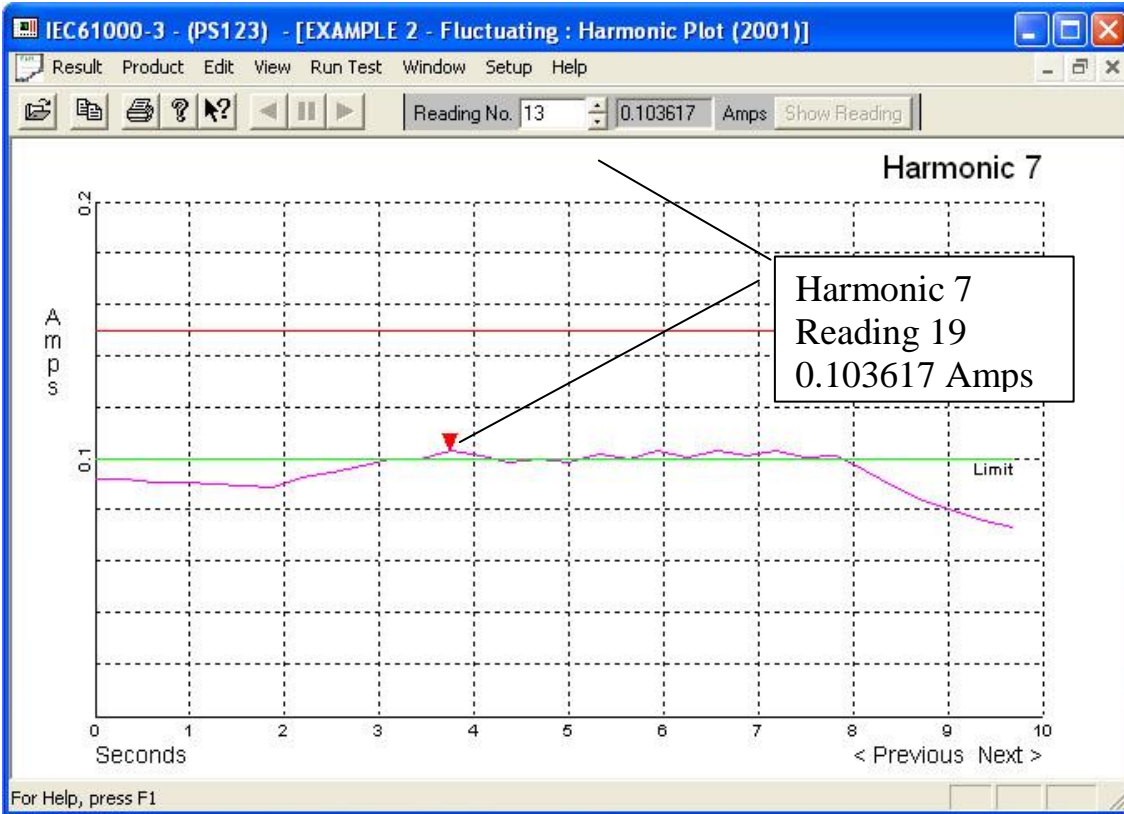

At the top of the main window, the reading number amplitude is shown that correspond to the position of the red marker. Click anywhere on the trace to re-position the marker.

Use the < and > keyboard keys to view the different harmonics.

Other Data Plot

These views show data other than harmonics as they vary during the duration of the test.

Watts and Amps

Shows the input watts and rms amps as measured by the analyzer. Input Watts is used to calculate limits for Class D tests and the user specified watts are also shown for comparison. The maximum measured watts should be within 10% of the user specified watts.

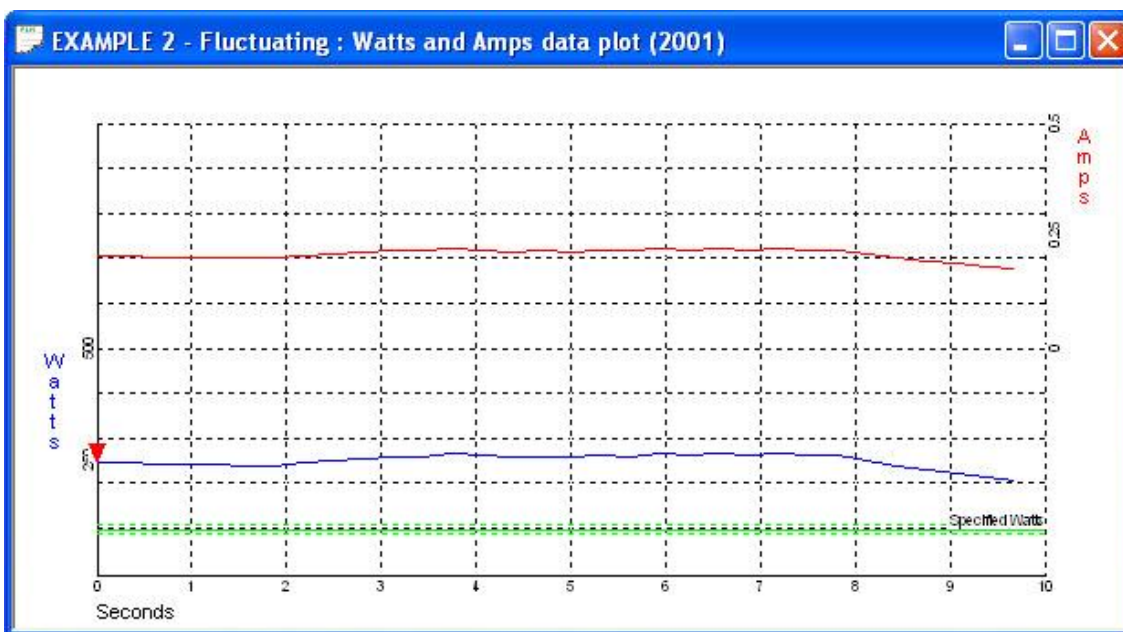

Click anywhere on this window to move the red marker and view details for the associated reading at the top of the main window.

Amps and Power Factor

This view shows the fundamental input current (amps) and power factor as they varied during the test together with their user specified levels. See the reference information for definitions of fundamental current and power factor.

Fundamental current and power factor are used to calculate limits for some Class C tests. The maximum measured fundamental current and power

factor should be within 10% of the user specified fundamental current and power factor.

Click anywhere on this window to move the red marker and view details for the associated reading at the top of the main window.

POHC and THC

See the reference information for definitions of these terms.

POHC is used during limit checking (see the reference information) .

Measurement of THC is not a specific requirement of the standard other than in the absence of specific guidelines, 'emission tests shall be conducted with the user's operation controls or automatic programs set to produce the maximum THC under normal operating conditions'.

Click anywhere on this window to move the red marker and view details for the associated reading at the top of the main window.

Source Qualification

This is a table view of the source voltage, frequency and harmonic content. Each parameter is allocated a PASS or FAIL according to the requirements of the standard.

4.12. PERFORMING A REPEATABILITY TEST

It is a condition of IEC61000-3-2 that 'the repeatability of the measurements shall be better than 5%.....'.

When more than one fluctuating harmonics result is available, they may be selected and a repeatability test performed. (This test is found under the 'result' menu).

To select results to test for repeatability, click on your first choice using the mouse and then hold the 'CTRL' key when mouse clicking on the others.

The list of results selected appear in the Results Description box. Click on OK to run the repeatability test.

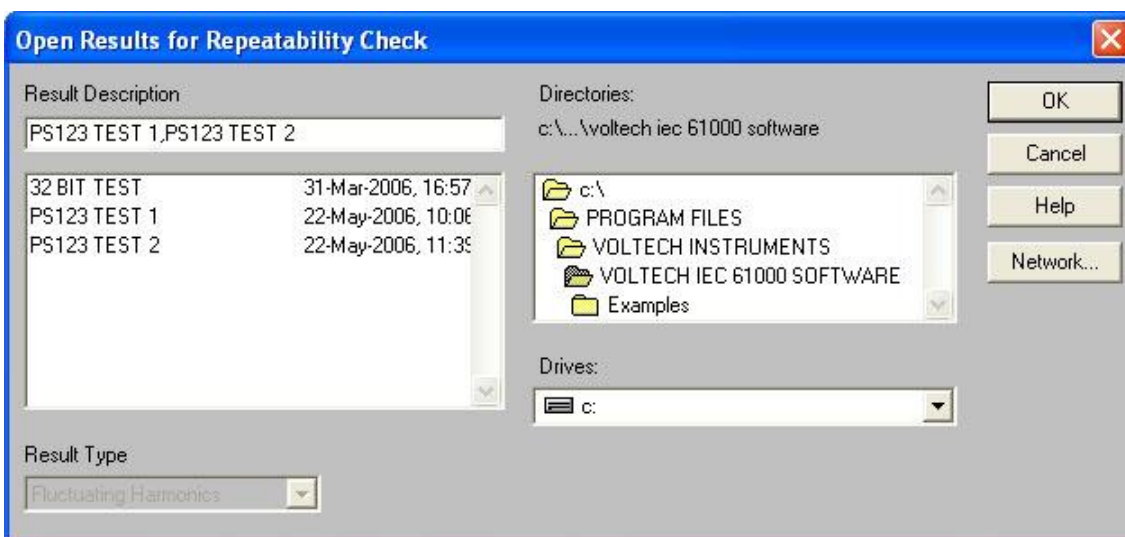

The repeatability test compares all the harmonic results for each harmonic from one set of results to every other to see if they are within 5%.

Harmonics less than 0.6% of the input current or less than 5mA are ignored.

After saving the repeatability result, a summary table of the chosen results is shown together with a PASS or FAIL for repeatability. If the test fails, some of the maximum differences are shown.

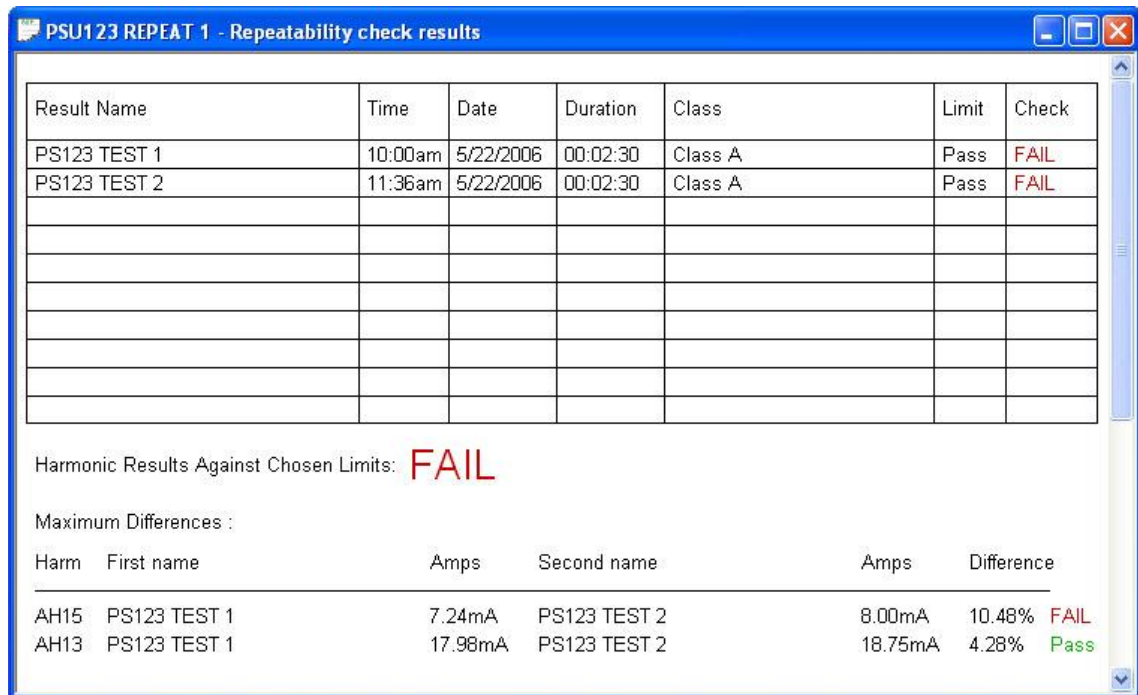

Result Name	Time	Date	Duration	Class	Limit	Check
PS123 TEST 1	10:00am	5/22/2006	00:02:30	Class A	Pass	FAIL
PS123 TEST 2	11:36am	5/22/2006	00:02:30	Class A	Pass	FAIL

Harmonic Results Against Chosen Limits: **FAIL**

Maximum Differences :

Harm	First name	Amps	Second name	Amps	Difference
AH15	PS123 TEST 1	7.24mA	PS123 TEST 2	8.00mA	10.48% FAIL
AH13	PS123 TEST 1	17.98mA	PS123 TEST 2	18.75mA	4.28% Pass

Should the repeatability test fail, ensure that the results selected refer to the same product tested under identical conditions.

4.13. PERFORMING A FLICKER TEST

To perform a Flicker Test for the power supply *PS123*, again connect it into the test rig as shown below.

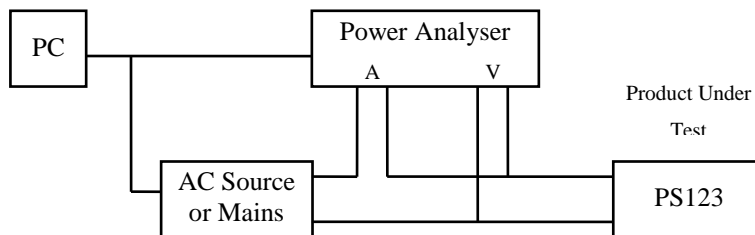

Again, it will be assumed that you are using the available Mains supply.

To set up the parameters for the flicker measurement:

From the Top Level menu, using the mouse, select

Product

Configure



At the next dialogue box:

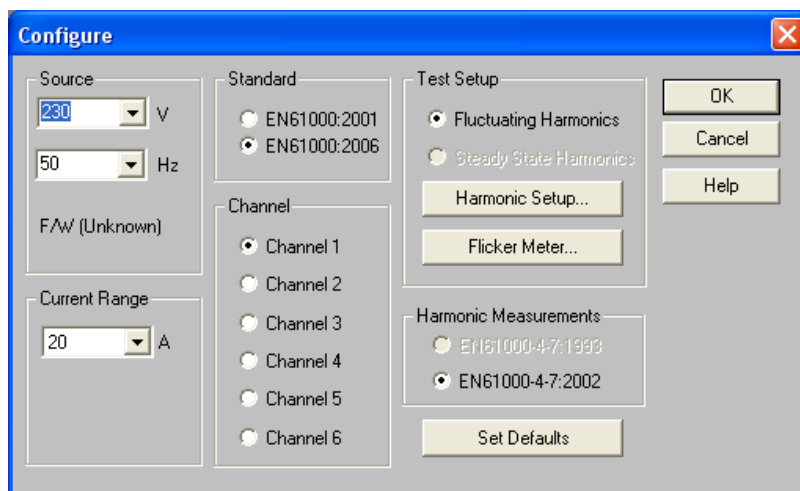

click on the Flicker Meter button to display:

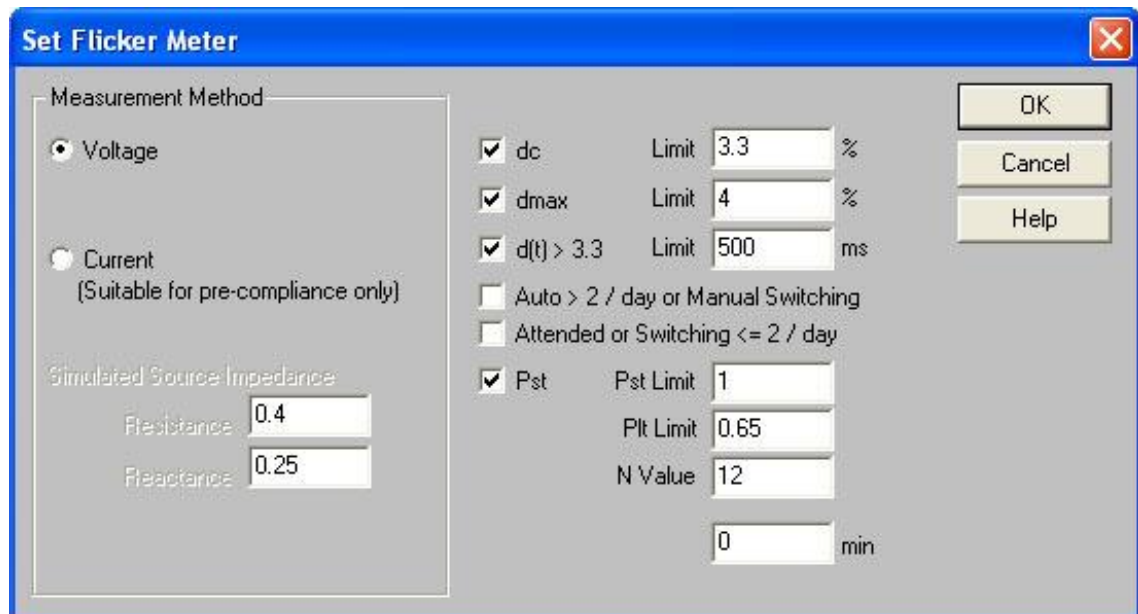

Normally, for full compliance testing, you would set the Measurement Method to Voltage, which would require you to insert a standard impedance network in the power line to the product under test. However, assuming that this time you want to use the measurement rig shown above for pre-compliance testing, click on the Current button in the Measurement Method box; the Resistance and Reactance default to the normal values specified in the IEC61000-3-3 Standard.

For the 2001 edition of the standard,

The dc limit is 3.3%

The dt limit is 500mS (the time for which the voltage characteristic exceeds a voltage change of 3.3%)

The dmax limit is:

- a) 4% without additional conditions
- b) 6% for equipment that is:
 - Switched manually

OR

- Switched automatically > twice per day

AND

- has EITHER a delayed restart (> 10's of seconds)

OR

- Manual restart after power supply interruption

(Choose 'Auto >2 / day or Manual Switching' to automatically set up this limit.)

c) 7% for equipment that is:

- Attended whilst in use

OR

- Switched on automatically or manually no more than twice per day

AND

- has EITHER a delayed restart (> 10's of seconds)

OR

- Manual restart after power supply interruption

(Choose 'Attended or switching <= 2 /day' to automatically set up this limit.)

The Pst limit is 1

The Plt limit is 0.65

The N value must be 12

The test duration must be 10 minutes for a Pst test, and should be 120 minutes (2 hours) for a Plt test.

(See the software help system for details of flicker test limits.)

When you have entered all the data, click on the OK button to return to the Configure display shown above, and from that, click on the OK button again to return to the Top Level display.

To run the Flicker test:

From the Top Level menu, using the mouse, select

Run Test
Flicker Meter



to bring up a sequence of dialogue boxes including the following:



As for the Fluctuating Harmonics test, ensure that the Mains supply is connected to the Product Under Test at the first display and click on the OK button. At the second display, ensure that the Product Under Test is switched on and has settled into steady state operation, and then click on the Start button.

The measurements will commence, and displays similar to the following will be seen.

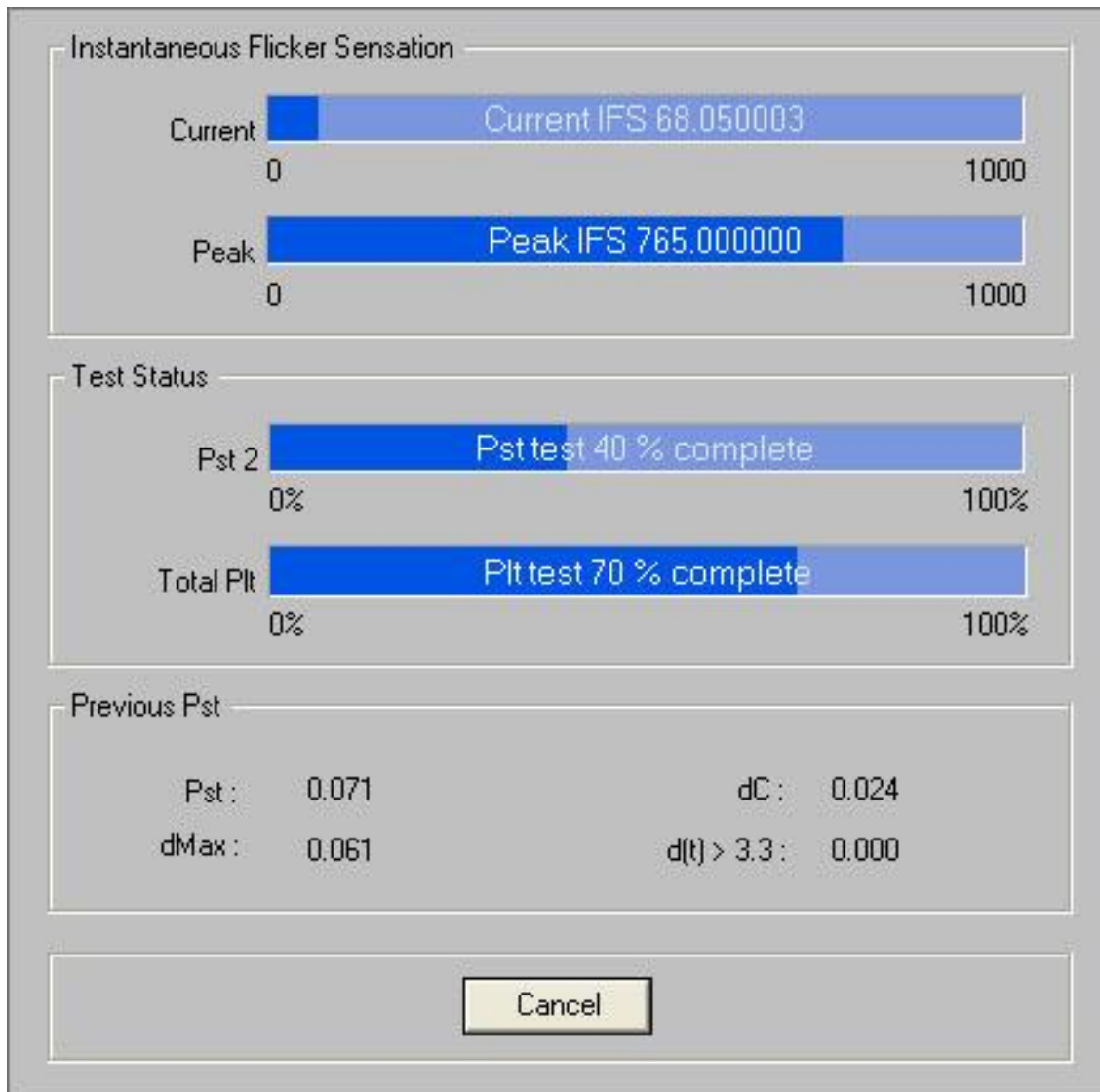

When the measurements are finished you will see:



Switch off the mains and click on the OK button. As with other measurements, you will again be prompted for a title for the saving of the result.

The measurement is now finished, and the result is displayed as a table. Again you can use the View menu to bring up an alternative graphical presentation - the Pst curves:

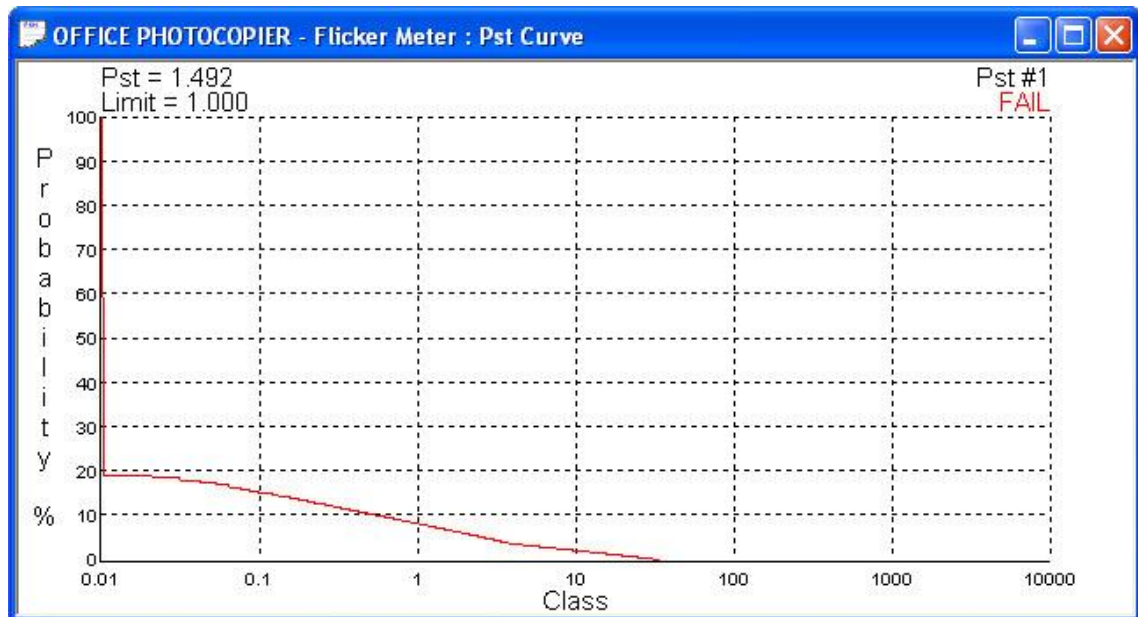

There will be a series of Pst curves - one for each ten-minute period in the measurement. You may view each curve in turn by using the < and > keys to scroll through the series.

If you wish to compare two or more results, from the Top Level menu, click on 'Result' and then 'Open' to bring up the Open Result dialogue box:

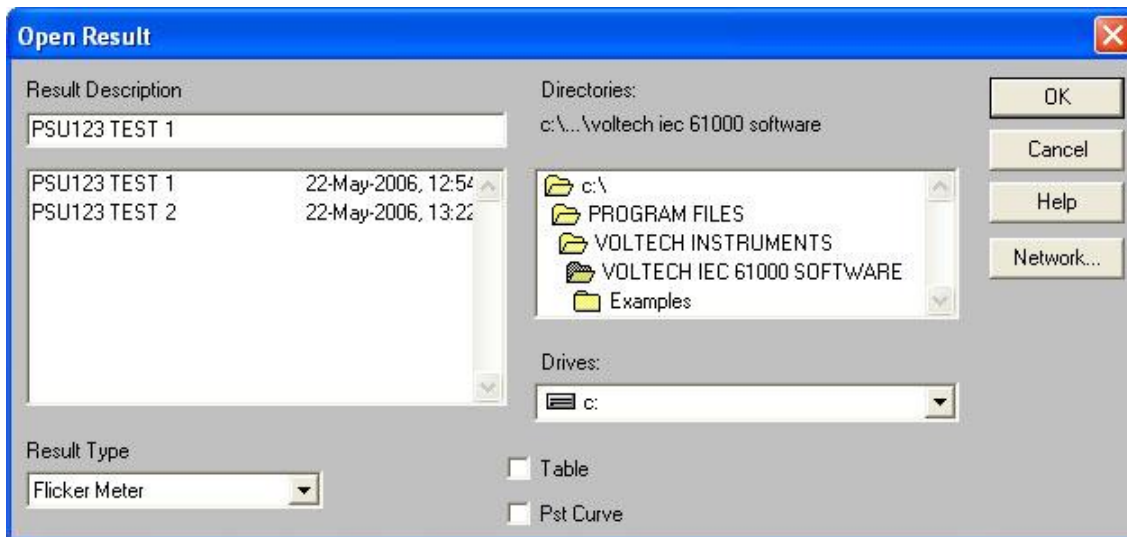

Initially change to the appropriate Drive and Directory. Then select the Result Type from the list revealed by clicking on the ▼ button; this will bring up a list of available results in the Result Description box. Finally, select the required result from the list by double-clicking with the mouse. This will close the dialogue box, and add the selected result to those already on view.

To remove a result from the display, simply select that result window by clicking on it with the mouse, and then from the Top Level menu, select Result Close.

4.14. PERFORMING A MANUAL SWITCHING TEST

The 2001 Edition of IEC61000-3-3 includes an Annex B that describes the procedure for measuring d_{max} caused by manual switching. This is a new procedure introduced to apply a statistical method to the voltage changes caused by manual switching which are subject to wide variations because of the behaviour of mechanical switches and the random point on the voltage cycle when the switch may operate.

To perform this measurement, 24 measurements of d_{max} are made each of one-minute duration.

For each one minute period:

- The measurement is started
- The equipment under test is switched on soon after the measurement is started
- The equipment under test is switched off before the end of the 1 minute period after operating for as long as possible, but in sufficient time for all moving parts inside the EUT to come to a standstill and that 'any d_{max} mitigation devices have had time to cool to the ambient temperature before the next measurement interval is started'.

At the end of the 24 tests, the highest and lowest values are discarded and the arithmetical average of the remaining 22 values is compared against the value used in the flicker meter setup.

To perform the test, select 'Manual Switching Test' from the 'Run Test' menu.



During the test the software automatically displays an ON prompt soon after the beginning of a one-minute test period and an OFF prompt before the end of a one-minute period.

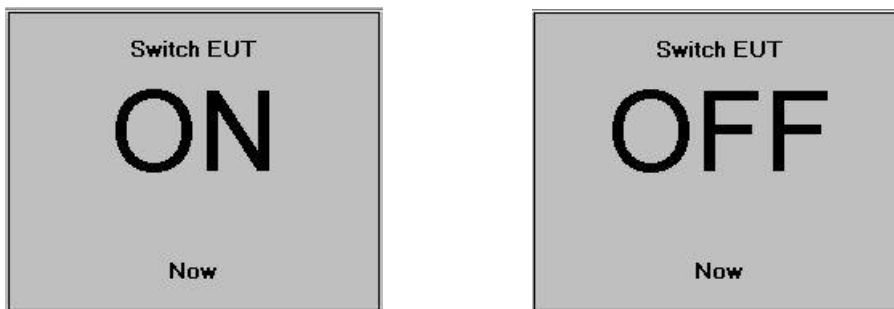

These are for guidance only - you may switch the equipment under test On and then Off once at any time during the test as long as you adhere to the guidelines above.

The values of d_c and d_t are shown for information only. At the end of the 24 1 minute tests, you are prompted to save the results and then the overall test result is shown. A cross indicates which two of the 24 results have been discarded.

4.15. RESULTS PRINTING

If you wish to print results, first open the result you wish to print and then click on 'Result', 'Print Preview' to check that all is satisfactory.

The screenshot shows a Windows-style application window titled "IEC61000-3 - (PS123)". At the top, there are navigation buttons: "Print...", "Next Page", "Prey Page", "Two Page", "Zoom In", "Zoom Out", and "Close". The main content area displays a test results report.

Test Report Summary:

Product:	HELP EXAMPLE	May 22 2008 12:04pm
Serial no:	5234	Page 1 of 1
Description:	You can edit the details at anytime. See 'Result', 'Change test data'	
Result Name:	EXAMPLE 1	
Voltech IEC61000-3 Windows Software: 4.03.03b	Test Date:	May 27 2007 16:04pm
Type of Test:	Fluctuating Harmonics Test - Worst Case Table (2005)	
Power Analyzer:	Voltech PNE000A v2.17 win 2073	
AC Source:	Main / Manual Source	
Overall Result:	Notice: Voltage harmonics outside permitted limits PASS Source voltage higher than nominal Voltage Crest Factor outside permitted limits	
Class:	Class D	
Class Multiplier:	1	

Test Results Table:

Item	Limit 1	Limit 2	Average	U1 +U2	Min Flucting	U3	Max	Item	Limit 1	Limit 2	Average	U1 +U2	Max Flucting	U3	Pass / Fail
1	Pass	Pass	1.22mV		7.22mV		Pass	1	100.0mV	100.0mV	100.0mV		100.0mV		Pass
2	Pass	Pass	1.13mV		7.00mV		Pass	2	175.0mV	175.0mV	175.0mV		175.0mV		Pass
3	Pass	Pass	2.13mV		7.40mV		Pass	3	350.0mV	350.0mV	350.0mV		350.0mV		Pass
4	Pass	Pass	1.20mV		7.20mV		Pass	4	525.0mV	525.0mV	525.0mV		525.0mV		Pass
5	Pass	Pass	1.70mV		7.70mV		Pass	5	700.0mV	700.0mV	700.0mV		700.0mV		Pass
6	Pass	Pass	1.17mV		7.00mV		Pass	6	875.0mV	875.0mV	875.0mV		875.0mV		Pass
7	Pass	Pass	1.20mV		7.20mV		Pass	7	1050.0mV	1050.0mV	1050.0mV		1050.0mV		Pass
8	Pass	Pass	1.47mV		7.40mV		Pass	8	1225.0mV	1225.0mV	1225.0mV		1225.0mV		Pass
9	Pass	Pass	1.20mV		7.20mV		Pass	9	1400.0mV	1400.0mV	1400.0mV		1400.0mV		Pass
10	Pass	Pass	1.20mV		7.20mV		Pass	10	1575.0mV	1575.0mV	1575.0mV		1575.0mV		Pass
11	Pass	Pass	1.20mV		7.20mV		Pass	11	1750.0mV	1750.0mV	1750.0mV		1750.0mV		Pass
12	Pass	Pass	1.20mV		7.20mV		Pass	12	1925.0mV	1925.0mV	1925.0mV		1925.0mV		Pass
13	Pass	Pass	1.20mV		7.20mV		Pass	13	2100.0mV	2100.0mV	2100.0mV		2100.0mV		Pass
14	Pass	Pass	1.20mV		7.20mV		Pass	14	2275.0mV	2275.0mV	2275.0mV		2275.0mV		Pass
15	Pass	Pass	1.20mV		7.20mV		Pass	15	2450.0mV	2450.0mV	2450.0mV		2450.0mV		Pass
16	Pass	Pass	1.20mV		7.20mV		Pass	16	2625.0mV	2625.0mV	2625.0mV		2625.0mV		Pass
17	Pass	Pass	1.20mV		7.20mV		Pass	17	2800.0mV	2800.0mV	2800.0mV		2800.0mV		Pass
18	Pass	Pass	1.20mV		7.20mV		Pass	18	2975.0mV	2975.0mV	2975.0mV		2975.0mV		Pass
19	Pass	Pass	1.20mV		7.20mV		Pass	19	3150.0mV	3150.0mV	3150.0mV		3150.0mV		Pass
20	Pass	Pass	1.20mV		7.20mV		Pass	20	3325.0mV	3325.0mV	3325.0mV		3325.0mV		Pass
21	Pass	Pass	1.20mV		7.20mV		Pass	21	3500.0mV	3500.0mV	3500.0mV		3500.0mV		Pass
22	Pass	Pass	1.20mV		7.20mV		Pass	22	3675.0mV	3675.0mV	3675.0mV		3675.0mV		Pass
23	Pass	Pass	1.20mV		7.20mV		Pass	23	3850.0mV	3850.0mV	3850.0mV		3850.0mV		Pass
24	Pass	Pass	1.20mV		7.20mV		Pass	24	4025.0mV	4025.0mV	4025.0mV		4025.0mV		Pass
25	Pass	Pass	1.20mV		7.20mV		Pass	25	4200.0mV	4200.0mV	4200.0mV		4200.0mV		Pass
26	Pass	Pass	1.20mV		7.20mV		Pass	26	4375.0mV	4375.0mV	4375.0mV		4375.0mV		Pass
27	Pass	Pass	1.20mV		7.20mV		Pass	27	4550.0mV	4550.0mV	4550.0mV		4550.0mV		Pass
28	Pass	Pass	1.20mV		7.20mV		Pass	28	4725.0mV	4725.0mV	4725.0mV		4725.0mV		Pass
29	Pass	Pass	1.20mV		7.20mV		Pass	29	4900.0mV	4900.0mV	4900.0mV		4900.0mV		Pass
30	Pass	Pass	1.20mV		7.20mV		Pass	30	5075.0mV	5075.0mV	5075.0mV		5075.0mV		Pass
31	Pass	Pass	1.20mV		7.20mV		Pass	31	5250.0mV	5250.0mV	5250.0mV		5250.0mV		Pass
32	Pass	Pass	1.20mV		7.20mV		Pass	32	5425.0mV	5425.0mV	5425.0mV		5425.0mV		Pass
33	Pass	Pass	1.20mV		7.20mV		Pass	33	5600.0mV	5600.0mV	5600.0mV		5600.0mV		Pass
34	Pass	Pass	1.20mV		7.20mV		Pass	34	5775.0mV	5775.0mV	5775.0mV		5775.0mV		Pass
35	Pass	Pass	1.20mV		7.20mV		Pass	35	5950.0mV	5950.0mV	5950.0mV		5950.0mV		Pass
36	Pass	Pass	1.20mV		7.20mV		Pass	36	6125.0mV	6125.0mV	6125.0mV		6125.0mV		Pass
37	Pass	Pass	1.20mV		7.20mV		Pass	37	6300.0mV	6300.0mV	6300.0mV		6300.0mV		Pass
38	Pass	Pass	1.20mV		7.20mV		Pass	38	6475.0mV	6475.0mV	6475.0mV		6475.0mV		Pass
39	Pass	Pass	1.20mV		7.20mV		Pass	39	6650.0mV	6650.0mV	6650.0mV		6650.0mV		Pass
40	Pass	Pass	1.20mV		7.20mV		Pass	40	6825.0mV	6825.0mV	6825.0mV		6825.0mV		Pass

U1 + U2 - Flucting in item table 1
 U3 - Flucting in item table 2
 Pass - Pass limit or above, Fail - Fail limit or below, No data - No data

Page 1

After version 1.10.04 the results report includes the power analyser's shunts and channels' serial number and calibration date information, like this:

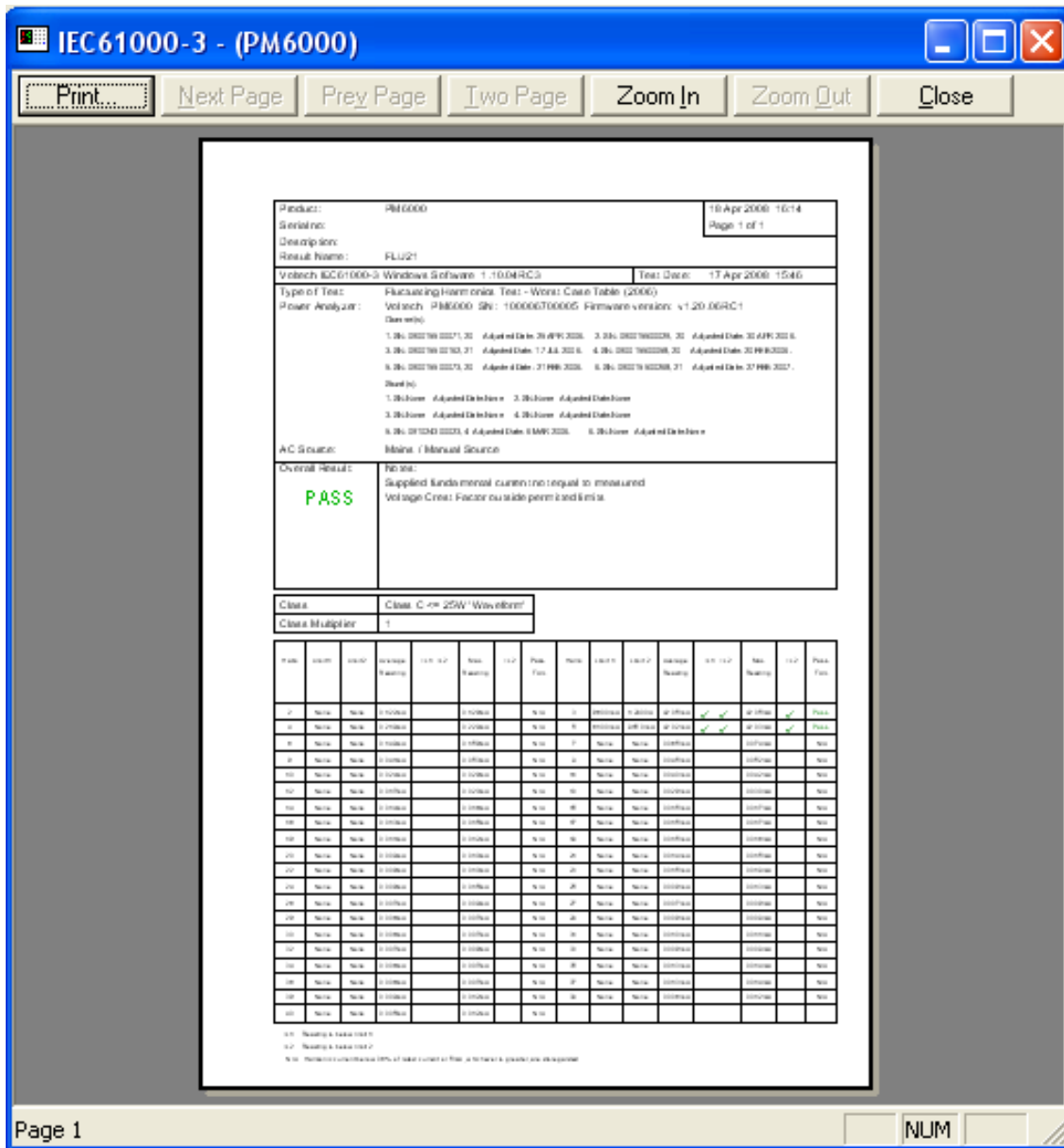

Then click on the Print button to start printing.

Note: The software before version 1.10.04 won't open the result file generated by the software after (included) version 1.10.04.

Standard windows printing commands are available in the print options. All printers supported by windows drivers can be used.

Print Header Option

This option can be found under the Result menu. The print header will appear at the top of the page on all printouts.

4.16. RESULTS EXPORT

This option is available from the 'results' menu for IEC61000-3-2 harmonics tests only when a test of that type is open.

You will be prompted for a file name and directory where the exported results will be stored.

You may export all of the available data in a form (comma separated variable) that is suitable for import into common spreadsheet applications. Since a large

number of results are produced every second of a fluctuating harmonics test, the exported file may be very large for tests of a long duration.

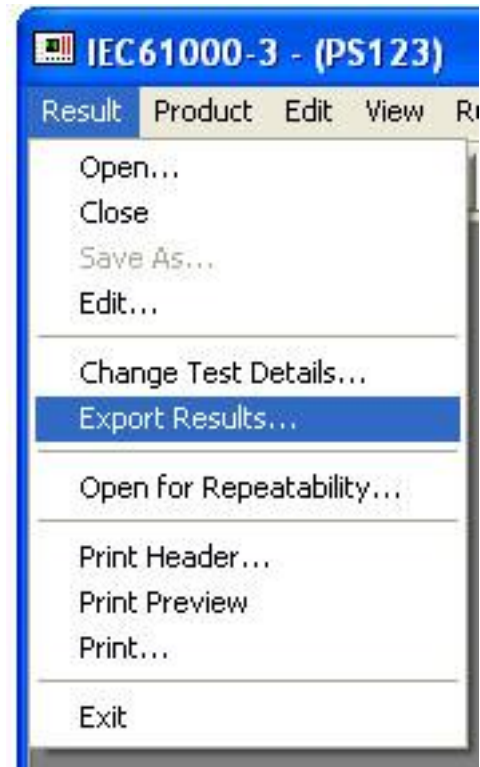

4.17. EXITING FROM THE IEC1000-3 SOFTWARE

When you have finished using the IEC1000-3 Software, select

Result

Exit

to quit the program.

5. ON-LINE HELP

Clearly, there is more functionality in the IEC61000-3 Software than has been covered in the Getting Started examples of the previous section. To assist you to make full use of its capabilities while you are actually running tests, the IEC61000-3 Software is equipped with extensive on-line help.

To access the on-line help, from the Top Level menu select

Help

Contents

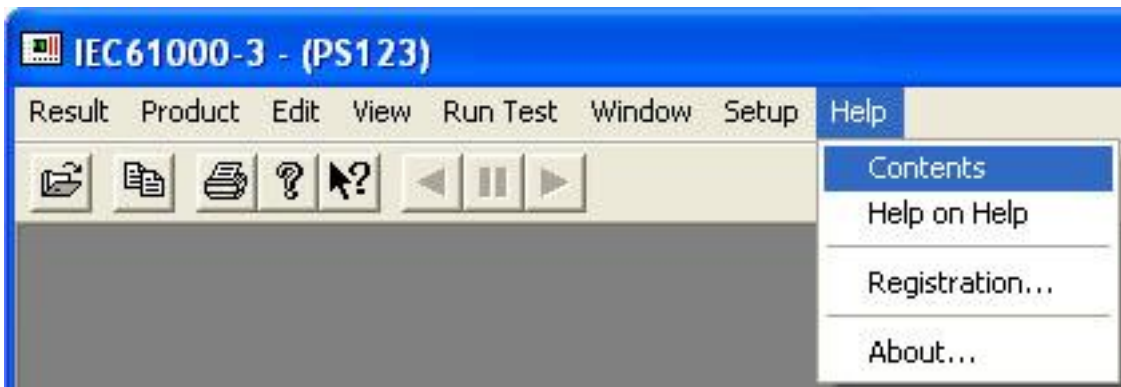

The Contents display is the starting point for many pages of on-line help, which function in the same way as any software package running under Windows.

For example, click on the words Step by Step User Guide, to lead on to:

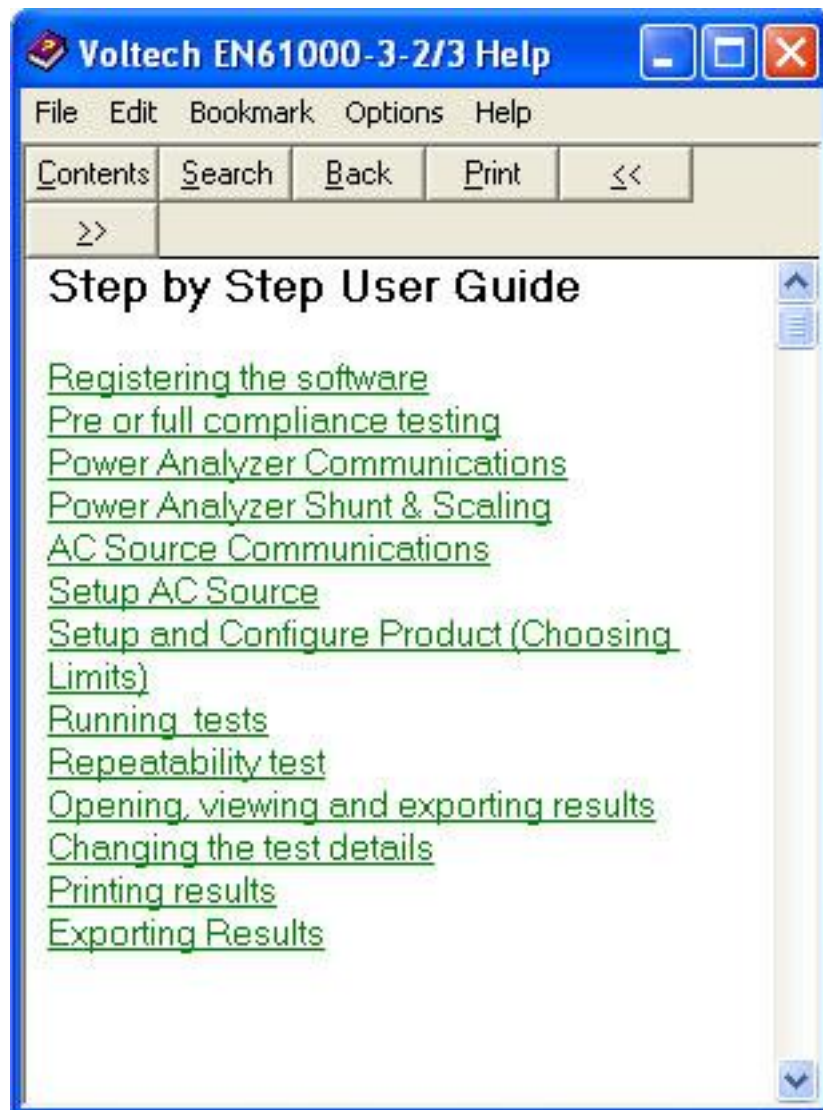

At the above display, click on the words of the topic of interest, to bring up the help dialogue.

Alternatively, click on the Search button to move to:

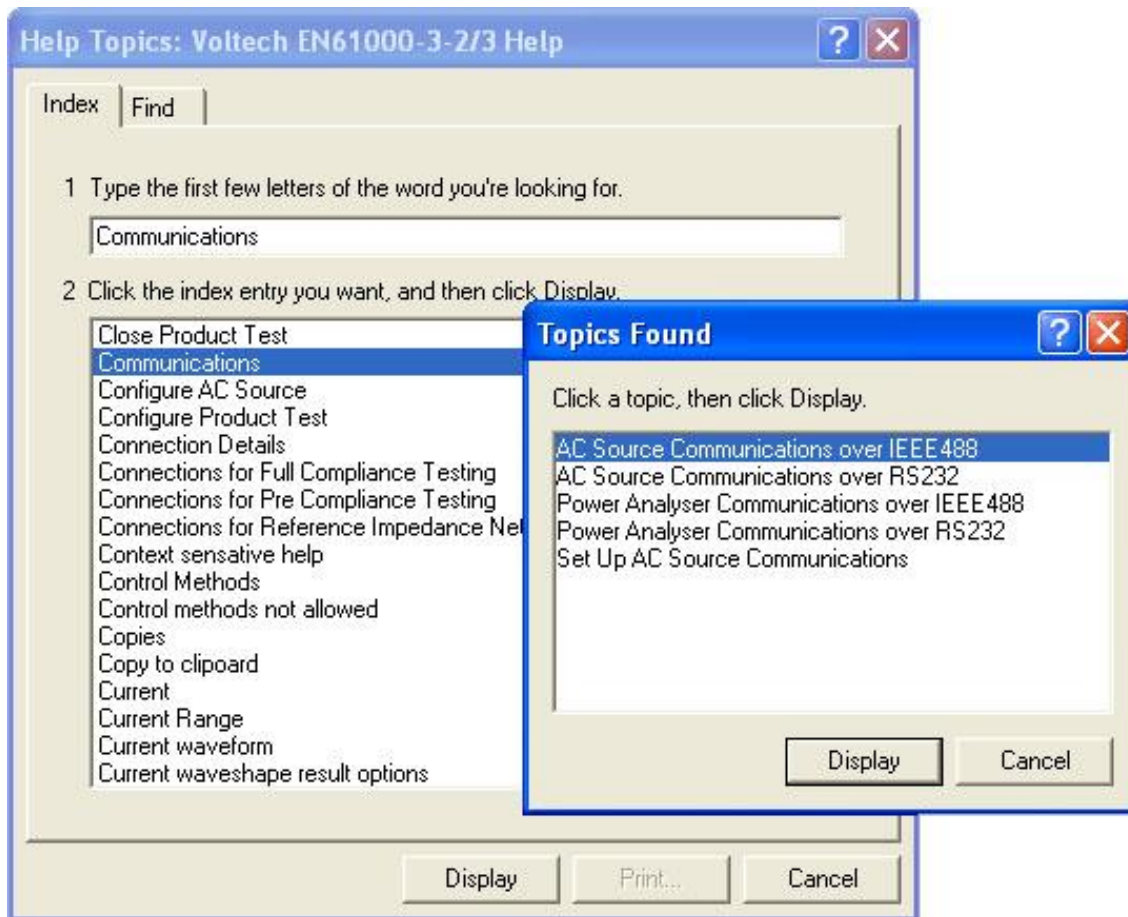

Using the mouse, scroll to the select a word from the central list and click on the Show Topics button.

Select a topic from the lower list, and click on the Go To button to bring up the required help text.

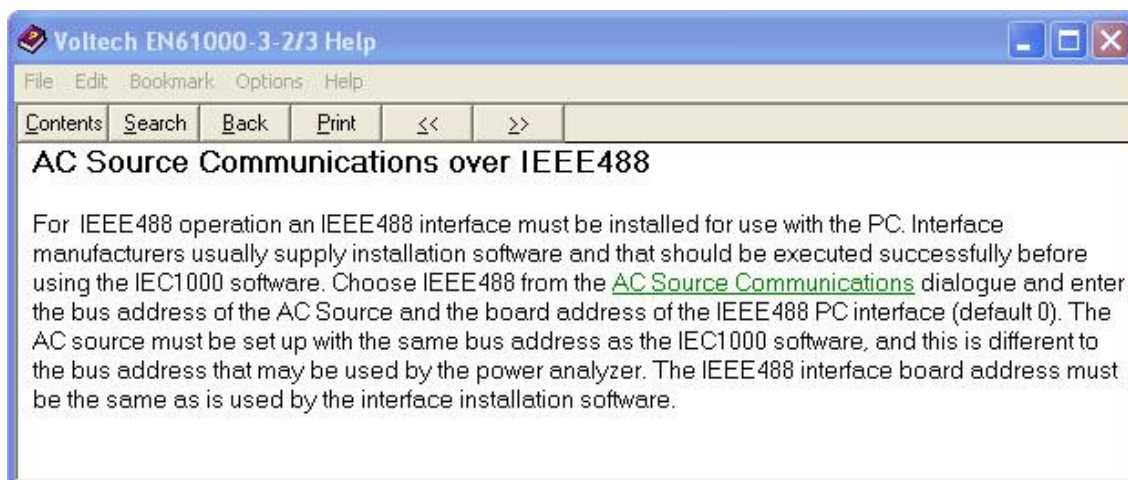

When you have finished with the on-line help,



select File ->Exit to return to the IEC61000-3 Software Top Level menu bar.

6. REFERENCE INFORMATION

Some of the information contained in this section is extracted from the versions of the standards available at the time of publication. Please refer to the relevant standards in force at the time of test for up to date information.

6.1. HOW THE ANALYSER PERFORMS A HARMONICS TEST

The 2001 & 2005 edition of IEC61000-3-2 defines exactly how the harmonic data from a Power Analyzer must be used when comparing them to the applicable limits.

(from section 6.2.2)

The measurement of harmonic currents shall be performed as follows:

- For each harmonic order, measure the 1.5 s smoothed rms harmonic current in each DFT time window....

(This is the same method used in previous versions. The analyzer calculates all 40 harmonic amplitudes every 10 cycles of the supply waveform without gaps or overlap. Each of the 40 harmonic amplitudes is smoothed by a filter with a 1.5 second time constant)

- Calculate the arithmetic average of the measured values from the DFT time windows over the entire observation.....

Also the input power, fundamental current and power factor are required to be measured in a very specific way. (These values are used to compute the limits for certain classes). Measurements of POHC and THC are also required for comparison with the limits and to determine test conditions.

These measurements are then compared to the limits in very specific ways.

Applying the 2001 limits.

The various class limits are compared to the measurements obtained in the following way:

(from 6.2.3.3)

1. The average value for the individual harmonic currents, taken over the entire test observation period shall be less than or equal to the applicable limits.
2. For each harmonic order, all 1.5s smoothed rms harmonic current values, shall be less than or equal to 150% of the applicable limits.

Applying the 2006 limits

The average values for the individual harmonic currents, taken over the entire test observation period shall be less than or equal to the applicable limits.

For each harmonic order, all 1.5s smoothed rms current values, as defined in 6.2.2, shall either:

- a) Less than or equal to 150% of the applicable limits or
- b) Less than or equal to 200% of the applicable limits under the following conditions, which apply all together
 1. The EUT belongs to Class A for harmonics
 2. The excursion beyond 150% of the applicable limits less than 10% of the test observation period or in total 10 min (within the test observation period), whichever is smaller, and
 3. The average value of the harmonic current, taken over the entire test observation period, is less than 90% of the applicable limits.

3. Harmonic currents less than 0.6% of the input current measured under the test conditions, or less than 5mA, whichever is greater, are disregarded.

4. For the 21st and higher odd order harmonics, the average values obtained for each individual odd harmonic over the full observation period, calculated from the 1.5s smoothed rms values may exceed the applicable limits by 50% provided that:

- the measured POHC does not exceed the POHC which can be calculated from the applicable limits;
- all 1.5 s smoothed rms individual harmonic current values shall be less than or equal to 150% of the applicable limits.

In other words the equipment under test meets the limits if you:

1. Measure the harmonics 2 to 40 of the input current for each and every consecutive 200ms@50Hz block of the measurement and smooth them with a 1.5 s time constant filter. For all these individual values of data, disregard small values and compare to 150% of the relevant class limit.

AND

2. Take the average value of the readings over the measurement period for each harmonic order, disregard small values and compare to the limits. (That's 39 averages compared to the limits).

ALSO

3. If the any of the odd average harmonics from 21 to 39 measured in (2) exceed the limit that's OK as long as:

- The measured POHC (for each 10 cycle block) does not exceed the POHC calculated from the limits.

AND

- Condition (1) is still met.

The combination of Voltech PM analyzer and associated software perform all the necessary measurements in strict accordance with the standards and present the results in an easy to understand graphical form.

6.2. GLOSSARY OF TERMS

Minimum Power

This is the power level specified by the standard, below which no limits apply. (Except for lighting equipment. When Class C is selected this field is inactive).

At the time of publication (2005) this value is 75 Watts.

May be reduced to 50W subject to approval of National Committees

Specified Power

The power of the equipment under test as specified by the 'manufacturer'.

The specified power is used to calculate limits for Class D and some Class C tests. This field is inactive when Class A or Class B is selected.

The power must be determined using the methods detailed below. If the power is unknown, it will be measured by the analyzer and this value can be entered retrospectively at the end of the tests and the limits re-computed accordingly.

(from 6.2.2 of the standard.....)

The value of input power to be used for calculation of limits shall be determined as follows:

- measure the 1.5s smoothed active input power in each DFT time window;
- determine the maximum of the measured values of power from the DFT time windows over the entire duration of the test.

The value for power, measured as defined in this clause, shall be specified by the manufacturer and documented in the test report. This value shall be used for establishing limits during emissions tests when limits are specified in terms of power. In order not to specify a power at which limits change

abruptly, thus giving rise to doubt as to which limits apply, the manufacturer may specify any value which is within 10% of the actual measured value.

The value for power found by measurement during emission tests other than the original manufacturer's conformity test, measured according to the terms of this clause, shall not be less than 90% nor greater than 110% of the value for power specified by the manufacturer. In the event that the measured value is outside of this tolerance band about the specified value, the measured power shall be used to establish limits.

If the 'specified' power is unknown, it will be measured by the analyzer and this value can be entered retrospectively at the end of the tests and the limits re-computed accordingly.

Fundamental Current

The fundamental current is used to calculate some Class C limits. This field is inactive when Class A, B or D is selected.

The fundamental input current is defined to be the maximum of the measured values of 1st harmonic current from the DFT time windows over the entire duration of the test.

If the fundamental current is unknown, it will be measured by the analyzer and this value can be entered retrospectively at the end of the tests and the limits re-computed accordingly.

Power Factor

The power factor is used to calculate some Class C limits. This field is inactive when Class A, B or D is selected.

The power factor is defined to be the ratio of volt-amperes to watts obtained from the same DFT measurement window as the value for the fundamental component of current.

If the power factor is unknown, it will be measured by the analyzer and this value can be entered retrospectively at the end of the tests and the limits re-computed accordingly.

POHC

Partial odd harmonic current is the total rms value of the odd harmonic components of orders 21 to 39. POHC is used during the application of limits.

$$POHC = \sqrt{\sum_{n=21,23}^{39} I_n^2}$$

THC

Total harmonic current is the total rms value of the harmonic components of orders 2 to 40.

$$THC = \sqrt{\sum_{n=2}^{40} I_n^2}$$

Although the measurement of THC is not specifically required by the standard, the standard requires that 'emission tests shall be conducted with the user's operation controls or automatic programs set to the mode expected to produce the maximum THC.' Maximum THC may also be used to determine the observation period for 'Long Cyclic' equipment.

6.3. EQUIPMENT WITHOUT LIMITS

(from section 7 of the IEC61000-3-standard)

For the following categories of equipment, limits are not specified in this edition of the standard.

- Equipment with a rated power of 75W or less, other than lighting equipment.
- Professional equipment with a total rated power greater than 1kW.
- Symmetrically controlled heating elements with a rated power less than or equal to 200W.
- Independent dimmers for incandescent lamps with a rated power less than or equal to 1kW.

6.4. CONTROL METHODS NOT ALLOWED

(From section 6.1 of the standard)

The following restrictions apply even to equipment to which no harmonic current limits apply as defined in clause 7.

- a) asymmetrical controls according to IEC 161-07-11, except where they are the only practical solution to detect unsafe conditions;
- b) half-wave rectification directly on the mains supply, except where it is the only practical solution to detect unsafe conditions, or, where the controlled active input power is less than or equal to 100W, or, where the controlled appliance is portable equipment and is fitted with a two-core flexible cord and is used for a short time, a few minutes only, for example hair dryers

Symmetrical control methods which are prone to produce harmonics of low order ($n < 40$) in the input current may be used for the control of the power

supplied to heating elements provided that the full sine-wave input power is less than or equal to 200W, or that the limits of table 3 are not exceeded.

Domestic equipment with symmetrical control used for a short time (for example hair dryers) shall be tested under Class A.

Even though asymmetrical controls and half-wave rectification are permitted under the conditions given above, the equipment shall still comply with the harmonic requirements of this standard.

6.5. IEC61000-3-2 HARMONICS TEST DURATION

The 'test observation period', T_{obs} is defined by section 6.2.4. of the standard.

The key criterion used to determine the observation period being that T_{obs} (is) 'of sufficient duration to meet the requirements for repeatability'.

Type of equipment behaviour	Observation Period	Voltech recommendation
Quasi-stationary	Sufficient duration to meet the requirements for repeatability	10 secs.
Short cyclic ($T_{cycle} < 2.5 \text{ min}$)	> 10 cycles (reference method) or sufficient duration to meet the requirements for repeatability	The cycle of operation of the equipment plus a few seconds. 10 secs. minimum
Random	Sufficient duration to meet the requirements for repeatability	2.5 minutes and check repeatability
Long cyclic ($T_{cycle} > 2.5 \text{ min}$)	Full equipment program cycle (reference method) or a 2.5 minute period considered....the operating period with the highest THC	Full equipment program cycle. 2.5 minutes minimum.

If in doubt, run at least two tests and check the repeatability.

For 'Long cyclic' equipment a full equipment cycle test can be run and period containing the highest THC determined (see 'Other data plot').

Repeat testing of equipment could than be tested using a 2.5 minute duration centred on the point when the equipment produces the highest THC.

6.6. HARMONIC TEST CONDITIONS IEC61000-3-2

(from Annex C of the standard)

Generic test conditions for IEC61000-3-2

(from section 6.2.1 of the standard)

For equipment not mentioned in Annex C, emission tests shall be conducted with the user's operation controls or automatic programs set to the mode expected to produce the maximum total harmonic current (THC) under normal operating conditions.

This defines the equipment set-up during emission tests and not a requirement to measure THC or to conduct searches for worst-case emissions.

The harmonic current limits specified in clause 7 apply to line currents and not to currents in the neutral conductor.

The equipment is tested as presented by, and in accordance with information provided by, the manufacturer. Preliminary operation of motor drives by the manufacturer may be needed before the tests are undertaken to ensure that results correspond with normal use.

Test conditions for television receivers

General conditions

Measurements shall include the loading of any auxiliary circuits included in the receiver, but exclude the loading of any peripheral equipment powered from the receiver.

Conditions for measurement

A radio frequency signal modulated in accordance with C 2.2.1 shall be supplied by a test generator and the receiver shall be adjusted to display a picture with appropriate settings for brightness, contrast and sound level in accordance with C 2.2.2.

C.2.2.1 The TV receiver is fed by an r.f. TV signal with a level of 65 dB/ μ V on 75W and with the following test modulations:

a) Colour Television

Radio frequency signal: a full TV signal with modulated picture chrominance and sound carrier.

- The sound modulation factor is 100% at 1000Hz.
- The picture modulation content is a colour bar test pattern with:

100%	reference white level bar;
0%	reference black level bar; and
75%	Amplitude (reference made to the white level) and;
100%	saturation.

b) Monochrome television

Radio frequency signal: a full TV signal with modulated picture and sound carrier.

- Sound modulation: see Item a) above.
- The picture modulation is a monochrome test pattern with a black and white level according to Item a) and an average overall picture content of 50% of the reference white level.

C.2.2.2 The receiver shall be tuned and adjusted according to Clause 37 of IEC publication 107-1

The white reference level corresponds to 80 cd/m² and the black level to less than 2 cd/m². The magenta bar corresponds to 30 cd/m².

The volume control is set in such a manner that one-eighth of rated output power is obtained, measured at the loudspeaker terminals, at a frequency of

1000Hz. In the case of stereophonic equipment, this output shall be present at both outputs.

Note -For devices that operate on base-band signals, a suitable video input signal should be used, and the same settings made for brightness, contrast and volume controls.

Test Conditions for audio amplifiers

Audio amplifiers which draw a supply current which varies by less than 15% of the maximum current with input signals between no signal and rated source e.m.f (as defined in IEC 268-3) shall be tested with no input signal.

- Other audio amplifiers shall be tested under the following conditions:
- rated supply voltage;
- normal position of user controls. In particular, any controls affecting the frequency response shall be set to give the widest flat response achievable;
- input signals and load conditions as given in clause 4.2.6b)of IEC 65.

Test conditions for videocassette recorders

Measurement shall be made on the playback mode with the standard tape speed.

Test conditions for lighting equipment

General Conditions

Measurements shall be made in a draught-free atmosphere and at an ambient temperature within the range from 20 to 27 deg C. During measurement the temperature shall not vary by more than 1K.

Lamps

Lamps shall be aged for at least 100h at rated voltage. They shall be operated for at least 15 minutes before a series of measurements is made. During ageing and measurement lamps shall be installed as in normal use. Note - Some lamp types may require a stabilising period exceeding 15 minutes. Corresponding information given in the relevant lamp specification must be observed.

Luminaires

The luminaire is measured as manufactured. It shall be tested with reference lamps, or with lamps having electrical characteristics close to their nominal values. In case of doubt measurements are made with reference lamps. When the luminaire incorporates more than one lamp, all lamps are connected and operated during the test. When the luminaire is assigned for use with more than one type of lamp, measurements shall be made with all the types and the luminaire shall comply each time. In each case where the luminaire is equipped with a glow starter, a starter in accordance with IEC Publication 155 shall be used.

Incandescent lamp luminaires that do not incorporate an electronic transformer or a dimming device are deemed to fulfil the harmonic current requirements and need not be tested.

If separate tests with reference lamps have proved that ballasts for fluorescent or other discharge lamps or step-down converters for tungsten halogen or other filament lamps comply with the requirements the luminaire is deemed to comply with these requirements and need not be checked. Where these components have not been approved separately or do not comply, the luminaire shall be tested and shall comply.

If a luminaire has a built-in dimming device, the harmonic currents shall be measured with the maximum load of the lamps as specified by the manufacturer. The setting of the dimming device is varied in 5 equidistant steps between the minimum and the maximum power in order to obtain comprehensive results.

Ballasts and step-down converters

Ballast for fluorescent or other discharge lamps or step-down converters for tungsten halogen or other filament lamps shall be tested with reference lamps or with lamps having electrical characteristics close to their nominal values. In case of doubt, measurements are made with reference lamps.

In the case where a ballast can be used with or without a series capacitor or where a ballast or step-down converter is designed for several types of lamps, the manufacturer shall indicate in his catalogue for which type of circuit and lamps the ballast fulfils the harmonic requirements and the ballast shall be tested accordingly.

Test conditions for independent and built-in incandescent lamp dimmers

The independent dimmer is tested with incandescent lamps having the maximum power allowed for the dimmer. The control is set to a firing angle of $90^\circ \pm 5^\circ$, or if controlled by steps, to that step closest to 90° .

Test conditions for vacuum cleaners

IEC61000-3-2:2001

The vacuum cleaner is tested with the air inlet adjusted according to the normal operation as defined in 2.2.9 of IEC 60335-2-2. The control is set to a firing angle of $90^\circ \pm 5^\circ$, or if controlled by steps, to that step closest to 90° .

IEC61000-3-2:2005

The air inlet of the vacuum cleaner is adjusted according to normal operation as defined in IEC60335-2-2.

During the test observation period, which shall not be shorter than 6 min, vacuum cleaners with electronic control are tested in three modes of operation, each for an identical time interval, with the control adjusted:

- to maximum input power,
- to a firing-angle of $90^\circ \pm 5^\circ$, or, if controlled by steps, to that step closest to 90° ,
- and to minimum input power.

NOTE: Alternatively, the equipment may be tested for 3 identical time intervals- each at least 2 min long - during which the vacuum cleaner is operated in the above three modes. These 3 time intervals need not be consecutive, but the application of limits is done as if the intervals were consecutive, without taking into account harmonic current values outside these 3 intervals.

If the vacuum cleaner includes a control to select a temporary high-power ('booster') mode of operation, which automatically returns to a lower power mode, this high-power mode is not considered for the calculation of the average values. This mode shall be tested only against the limits for single 1.5s smoothed r.m.s. values.

Test conditions for washing machines

The washing machine is tested in the normal 60°C laundry program. It is filled with normal load of cotton cloths, size 70cm × 70cm, dry weight from 140 to 175 g/m², as specified in IEC 335-2-7.

Normally it is sufficient to measure the harmonics during the rinsing; in case of doubt a full programme is tested. Transitory harmonics are measured during a few reversing speed-up operations during the spinning speed-up operation.

Test conditions for microwave ovens

The microwave oven is tested with 100% nominal power. It is operated with a potable water load of initially 1000 ± 50 g in a cylindrical borosilicate glass vessel having a maximum material thickness of 3mm and an outside diameter of approximately 190mm. The load is placed at the centre of the shelf.

Test conditions for Information Technology Equipment (ITE)

ITE is tested with the equipment configured to its rated current. In this case the equipment, if necessary, may be configured with its power supplies loaded with additional load (resistive) boards to simulate rated current conditions.

For ITE systems designed for use with a manufacturer-supplied power distribution system, i.e. transformers, UPS, power conditioner etc., compliance with the limits of this Standard shall be met at the input to the power distribution system.

Test conditions for induction hobs

Induction hobs are operated with an enamelled steel pan, which contains approximately half its capacity of water at room temperature, and positioned at the centre of each cooking zone, in turn. Thermal controls are adjusted to their highest setting.

The diameter of the base of the pan is to be at least the diameter of the cooking zone. The smallest pan complying with this requirement is used. The maximum concavity of the base of the pan is $3D/1000$ where D is the

diameter of the flat area of the base of the pan. The base of the pan is not to be convex.

The concavity is checked at room temperature using an empty pan.

6.7. FLICKER TEST CONDITIONS IEC61000-3-3:2008

General test conditions

The test conditions for the measurement of flicker are given in the following clauses. For equipment not mentioned in Specific test conditions list, controls or automatic programmes shall be set to produce the most unfavourable sequence of voltage changes using only those combinations of controls and programmes that are mentioned by the manufacturer in the instruction manual, or are otherwise likely to be used. Particular test conditions for equipment not included in the Specific conditions list are under consideration.

The equipment shall be tested in the condition in which it is supplied by the manufacturer. Preliminary operation of motor drives may be needed before the tests to ensure that results corresponding to those of the normal use are obtained.

- For motors, locked-rotor measurements may be used to determine the largest rms voltage change, d_{max} , occurring during motor starting.
- For equipment having several separately controlled circuits, the following conditions apply:
- Each circuit shall be considered as a single item of equipment if it is intended to be used independently, provided that the controls are not designed to switch at the same instant.

If the controls of separate circuits shall be designed to switch simultaneously, the group of circuits so controlled are considered as a single item of equipment.

For control systems regulating part of a total load only the voltage fluctuations produced by each variable part of the load alone shall be considered.

Test conditions for cookers

For cookers designed for use in domestic premises the evaluation of Plt shall not be required.

The tests of Pst shall be performed at steady state temperature conditions unless otherwise stated.

Each heater shall be tested separately as follows:

Hot plates

Hot plates shall be tested using standard saucepans with diameter, height and water quantity as follows:

Diameter of the hotplate(mm)	Height of the pot(mm)	Quantity of water(g)
145	about 140	1000+/-50
180	about 140	1500+/-50
220	about 120	2000+/-50

Possible losses by evaporation have to be compensated for during the time of measurement.

In all the following tests the hot plate shall comply with the specified limits.

a) Boiling temperature range: Set the control to the position where the water just boils. The test is made 5 times and the mean value of the test results calculated.

b) Frying temperature range: Fill the pot, without a lid, with silicone oil to 1.5 times the quantity of water shown in the table. Set the control to a temperature of 180°C measured by a thermocouple in the geometric centre of the oil.

c) Total range of power settings: The total power range shall be checked continuously during a ten-minute observation period. If control switches have discrete stages, test all stages up to a maximum of 20 stages. If there are no discrete stages divide the total range into 10 equally spaced steps. The measurements shall then be made starting at the highest power stage.

Baking ovens

The oven shall be tested empty with the door closed. Adjust the control so that a thermocouple fixed in the geometric centre measures a mean temperature of 220°C for conventional ovens and 200°C for hot air ovens.

Grills

The grill shall be tested empty with the door closed if not otherwise stated by the manufacturer. If a control is available it shall be set to the lowest, medium and highest setting for grilling operation and the worst result recorded.

Baking oven/grill combinations

The oven/grill combination shall be tested empty with the door closed. Adjust the control so that a thermocouple fixed in the geometric centre measures a mean temperature of 250°C or that available temperature closest to this value.

Microwave ovens

The microwave oven or the microwave function of a combination oven shall be tested at the lowest, medium and a third stage that is the highest adjustable power less than or equal to 90% of the maximum power. Load the oven with a glass bowl containing 1000 ± 50 g of water.

Test conditions for lighting equipment

The following test conditions shall apply to equipment with a primary function of generating and/or regulating and/or distributing optical radiation by means of incandescent or discharge lamps or LEDs.

Such equipment shall be tested with a lamp of that power for which the equipment is rated. If lighting equipment includes more than one lamp, all lamps shall be in use.

Pst and Plt evaluations are required only for lighting equipment that is likely to produce flicker; for example: disco lighting and automatically regulated equipment.

No limits shall apply to lamps.

Incandescent lamp luminaires with ratings less than or equal to 1000W and discharge lamp luminaires with ratings less than or equal to 600W, are deemed to comply with the d_{max} limits in this standard and are not required to be tested. Luminaires with higher ratings, which cannot comply with this part of IEC61000, shall be subject to conditional connection in accordance with IEC61000-3-11.

Ballasts are deemed to be part of luminaires and are not required to be tested.

Test conditions for washing machines

The washing machine shall be tested in a complete laundry programme incorporating the normal wash-cycle filled with the rated load of double hemmed, pre-washed cotton cloths' size approximately

70cm x 70cm, dry weight from 140 g/m² to 174 g/m².

The temperature of the fill water shall be

- 65°C \pm 5°C for washing machines without heater elements;
- 15°C \pm 5°C for other washing machines

For washing machines with a programmer, the 60°C cotton programme without pre-wash shall be used.

If the washing machine does not incorporate a programmer, the water is heated to 90°C \pm 5°C or lower if steady conditions are established, before starting the first wash period.

Neglect simultaneous switching of heater and motor in the evaluation of dc, dmax and d(t).

Pst and Plt shall be evaluated.

Test conditions for tumbler dryers

The dryer shall be tested with 50% of the load as specified for normal operation in IEC 335-2-11

If a control of the drying degree is available the test shall be performed at the maximum and minimum settings.

Pst and Plt shall be evaluated.

IEC61000-3-3:A2

Replace the first paragraph with the new following paragraphs:

The tumble dryer shall be operated with the drum filled with textile material having a mass in the dry condition of 50% of the maximum load stated in the instruction for use.

The textile material consists of pre-washed double-hemmed cotton sheets, approximately 70cm \times 70cm, having a mass between 140 g/m² and 175 g/m² in the dry condition. The material shall be soaked with water having a temperature of 25 °C \pm 5 °C and a mass of 60% of that of the textile material.

Test conditions for refrigerators

Refrigerators shall be operated continuously with the door closed. Adjust the thermostat to the mid-value of the adjusting range. The cabinet shall be

empty and not heated. The measurement shall be made after a steady state has been reached.

Pst and Plt shall not be evaluated.

Test conditions for copying machines, laser printers and similar appliances

The appliance is tested for Pst at the maximum rate of copying. The original to be copied/printed is white blank paper and the copy paper should have a weight of 80g/m² if not otherwise stated by the manufacturer. Obtain the Plt value in the stand-by mode.

Test conditions for vacuum cleaners

For vacuum cleaners, Pst and Plt shall not be evaluated.

Test conditions for food mixers

For food mixers, Pst and Plt shall not be evaluated.

Test conditions for portable tools

For portable tools, Plt shall not be evaluated. For portable tools without heating elements, Pst shall not be evaluated. For portable tools with heating elements, Pst shall be evaluated as follows:

Switch on the tool and allow to operate continuously for 10 minutes, or until it switches off automatically, in which case the general observation period applies.

Test conditions for hairdryers

For hand held hairdryers Plt shall not be evaluated. To evaluate Pst, switch on the hairdryer and allow to operate continuously for 10 minutes or until it

switches off automatically, in which case the general observation period applies.

For hairdryers incorporating a power range, check the total power range continuously during a ten-minute observation period. If control switches have discrete stages all stages shall be tested up to a maximum of 20 stages. If there are no discrete stages divide the total range into 10 equally spaced steps. The measurements shall then be made starting with the highest power stage.

Test conditions for consumer electronics products

For consumer electronic products, only the measurement of d_{max} is made.

Test conditions for direct water heaters

For direct water heaters without electronic controls evaluate d_c only by switching the heater on and off (sequence 0 - P_{max} - 0).

For direct water heaters with electronic controls the output temperature of the water has to be chosen so that by means of the variation of water flow-rate all electric power consumption rates between P_{min} and P_{max} may be produced. P_{max} is defined as the minimum power that can be chosen, and $P_{min} > 0$ is defined as the minimum power that can be chosen.

NOTE - For some appliances the maximum power P_{max} that can be chosen may be less than the rated power.

The set temperature value shall be kept unchanged during the total test.

Starting from the water-flow rate demand for maximum power consumption, P_{max} , reduce the rate of flow in 20 approximately equal steps to minimum power consumption, P_{min} .

Then, in another 20 approximately equal steps, increase the water flow-rate to power consumption P_{max} . For each of these 40 stages the $P_{st. i}$ value shall be evaluated; the measurements start when the steady state is reached, i.e. about 30 seconds after changing the water flow-rate.

NOTE - It may be sufficient to calculate Pst. i value on the base of a measurement period of only 1 min.

Additionally, the flicker Pst. z caused by switching the heater on and off has to be measured within a ten-minute interval. In this interval the power consumption has to be changed twice in the quickest possible way between the stages P = 0 and P = Pmax (sequence: 0 - Pmax - 0 - Pmax - 0)

The duty cycle of the heater shall be 50% that is Pmax during 5 minutes.

Evaluate the resultant Pst value by:

$$P_{st} = \left(P_{st,z}^3 + \frac{1}{40} \sum_{i=1}^{i=40} (P_{st,i})^3 \right)^{\frac{1}{3}}$$

and compare against the limit value.

Plt shall not be evaluated.

Test conditions for arc welding equipment and allied processes

For arc-welding equipment, attended whilst in use, and allied processes, dmax shall be evaluated against the 7% limit for manual switching using the 24-measurement method.

Additionally, equipment designed to be used for the Manual Metal Arc (MMA) process, Pst and dc values shall be evaluated according to the procedures defined in the standard.

Notes

7. RELEASE HISTORY

Software Version: 1.00.01

PM6000 Firmware: 1.08.02

Release: August, 2006

- IEC 61000 Software for PM6000 initial released.

Software Version: 1.02.01

PM6000 Firmware: 1.09.02

Release: October, 2006

- Manual switching now fully functional
- Problem with high IFS (i.e. 8000+) and Pst values (16 instead of 1) under certain load conditions fixed.

Software Version: 1.05.02

PM6000 Firmware: 1.17.05

Release: September, 2007

2006 Limit checking implemented

The average values for the individual harmonic currents, taken over the entire test observation period shall be less than or equal to the applicable limits.

For each harmonic order, all 1.5s smoothed rms current values, as defined in 6.2.2, shall either:

- a) Less than or equal to 150% of the applicable limits or
- b) Less than or equal to 200% of the applicable limits under the following conditions, which apply all together
 - 1) The EUT belongs to Class A for harmonics

- 2) The excursion beyond 150% of the applicable limits less than 10% of the test observation period or in total 10 min (within the test observation period), whichever is smaller, and
- 3) The average value of the harmonic current, taken over the entire test observation period, is less than 90% of the applicable limits.

Software Version: 1.11.05RC1

PM6000 Firmware: 1.20.06RC4

Release: July, 2008

- Implemented Ethernet communication method
- Updated the help about the analyser communications setup
- Fixed a problem with flicker meter progress bar stops before 100% displayed
- Added PM6000 test channel number and shunts serial number on the results report
- .Make this new version software can open result files that generated by previous version software
- Fixed a bug with Print preview Normalized Worst Case Bar Chart
- Updated help to:
 - correct baud rates for AC source
 - refer to amendment 2 of -3-3
- Fixed problem with select of comms method for AC source
- Fixed problem with baud rates for AC source
- Change EN61000:2001 to EN61000:2000 as this is the correct standard.

Software Version: 1.11.05RC1

PM6000 Firmware: 1.20.06RC4

Release: July, 2008

- Fixed problem with page number of Flicker Meter Pst Curve print page.

Software Version: 1.13.06RC1

PM6000 Firmware: 1.20.06RC4

Release: October, 2008

- Fixed problem with manual switching report running over the end of the page
- Added the ability to run the waveform check after every test version

Software Version: 1.14.06RC1

PM6000 Firmware: 1.20.06RC4

Release: April, 2009

- Help updated to reflect meeting -3-3:2008
- Change waveform to only run when the channel selected is 1
- Stopped the ability to over write a product title of the same name in the same directory.

Software Version: 1.15.07RC1

PM6000 Firmware: 1.21.07RC2

Release: May, 2010

- Changed the class C detection code to meet amendment 2 to IEC 61000-3-2 edition 3.
- Updated the help to reflect this change.