

PM1000+
POWER ANALYZER
USER MANUAL

Need help?

Thank you for choosing to use this Voltech Power Analyzer. It has been designed to be safe and easy to use.

If you have any questions about any of our products, or are unsure of any of their features or abilities, please do not hesitate to contact either your local supplier or visit our **applications support** center at **www.voltech.com**

Voltech Instruments Inc.
12851 Banyan Creek Drive
Fort Myers, FL 33908
U.S.A.
Tel: 239 437 0494
Fax: 239 437 3841
sales@voltech.com

Voltech Instruments Ltd.
148 Harwell Business Centre
Didcot, Oxon, OX11 0RA
U.K.
Tel: +44 1235 834555
Fax: +44 1235 835016
sales@voltech.co.uk

Voltech Instruments is committed to a policy of continuous product development. Hence product specification and the information given in this manual are subject to change without notice.

No part of this publication may be reproduced, stored in a retrieval system, or transmitted in any form, or by means electronic, mechanical photocopying, recording or otherwise, without prior written permission of Voltech Instruments.

© 2011 Voltech Instruments. All rights reserved.

Microsoft, Windows and the Windows logo are either registered trademarks or trademarks of Microsoft Corporation in the United States and/or other countries.

Voltech Part Number: 98-115

Manual Issue	PM1000+ Firmware Revision
14	V4.24 and above

For the latest version of the manual and firmware please see our website at www.voltech.com.



DANGER OF ELECTRIC SHOCK

Only qualified personnel should install this equipment, after reading and understanding this user manual. If in doubt, consult your supplier.



RISQUE D'ELECTROCUTION

L'installation de cet équipement ne doit être confiée qu'à un personnel qualifié ayant lu et compris le présent manuel d'utilisation. Dans le doute, s'adresser au fournisseur.



GEFAHR VON ELEKTRISCHEM SCHOCK

Nur entsprechend ausgebildetes Personal ist berechtigt, diese Ausrüstung nach dem Lesen und Verständnis dieses Anwendungshandbuches zu installieren. Falls Sie Zweifel haben sollten, wenden Sie sich bitte an Ihren Lieferanten.



RISCHIO DI SCARICHE ELETTRICHE

Solo personale qualificato può installare questo strumento, dopo la lettura e la comprensione di questo manuale. Se esistono dubbi consultate il vostro rivenditore.

IMPORTANT: Please consult the safety information section of this user manual before installation and use.

Contents

1. Introduction.....	9
1.1. Features & Abilities.....	9
1.2. Package Contents.....	11
1.3. Accessories.....	11
2. Quick Start.....	12
2.1. Power On.....	12
2.2. Connecting to the Product Under Test.....	13
2.3. Default Measurements.....	14
2.4. Navigating the Menu System.....	15
2.5. Menu Keys.....	16
2.6. Example: Choosing Measurements to Display.....	16
2.7. Key Shortcuts.....	17
2.8. Printing.....	17
2.9. Data Logging.....	18
2.10. Unit Configuration.....	20
3. Using Voltage and Current Transducers.....	21
3.1. Input Overview.....	21
3.2. To connect a Simple Current transformer.....	22
Current Scaling.....	22
3.3. To connect an external resistive shunt:.....	23
3.4. To connect a transducer with a voltage output	25
3.5. To connect a Voltage Transformer / Transducer.....	26
Voltage Scaling.....	26
4. The Menu System.....	27
4.1. Navigation.....	27
4.2. Menu Items.....	27
4.3. Main Menu	27
4.4. Measurements.	27

4.5. Modes	28
Select Mode	28
Setup Mode	30
4.6. Inputs	31
Fixed/Auto Ranging	31
Scaling	31
Frequency Source	32
Frequency Filter	32
Shunts	32
Blanking	33
Averaging	33
4.7. Graphs	33
Waveform Graph	33
Harmonic Bar Chart	33
Integration Graph	34
4.8. Interfaces	34
RS232 Baud Rate	34
GPIB Address	34
Printer Select	35
Ethernet Configure	35
4.9. System Configuration	36
Harmonics Setup	36
Distortion Setup	36
Auto Zero	36
Clock Setup	37
Unit Configuration	37
IEC Key Code Entry	37
4.10. User Configuration	37
4.11. View	38
Zoom	38
Contrast	38
5. Remote Operation	39

5.1. Overview.....	39
5.2. Command Listing.....	39
5.3. Sending and Receiving Commands.....	46
5.4. Communications examples.....	47
Basic selection and returning of result.....	47
Returning Results Repeatedly.....	48
Harmonics.....	48
Standby power.....	49
Inrush	49
5.5. Status Reporting.....	51
Status Byte.....	51
Status Byte Register (STB).....	51
Display Data Status Register (DSR).....	52
Display Data Status Enable Register (DSE).....	52
Standard Event Status Register (ESR).....	53
Standard Event Status Enable Register (ESE).....	53
6. Software.....	54
6.1. IEC 61000-3-2/3 Pre-Compliance Software.....	54
Aim.....	54
Where to find it.....	54
Software Installation.....	54
Hardware Setup.....	55
Running the Fluctuating Harmonics Test.....	56
Running the Flicker Test.....	63
Reporting Results.....	66
6.2. IEC 62301 Low Power Standby Software.....	68
6.3. PM1000+ General Purpose Measurement Software.....	68
7. Specification.....	70
7.1. Mechanical.....	70
Accessories.....	70
7.2. Power Supply.....	70
7.3. Communications.....	70

RS232.....	70
AUX/TRIG.....	71
GPIB.....	71
USB Peripheral (USB Test and Measurement Class [USBTMC]).....	71
7.4. Measured Parameters.....	72
7.5. Measurement Accuracy.....	74
Example of Volts, Amps and Watts Accuracy Calculations.....	78
8. Warranty, Service and Updates.....	80
8.1. Warranty.....	80
8.2. Calibration and Service.....	80
8.3. Obtaining Service and Applications Support.....	81
8.4. Updating Firmware.....	81
8.5. Language Upload Option.....	81
9. Safety Information.....	83
9.1. Safety Features.....	83
9.2. Safety Instructions.....	83
9.3. Declaration of Conformity.....	85
10. Release History.....	86

1. INTRODUCTION

1.1. FEATURES & ABILITIES

The Voltech PM1000+ is a powerful and versatile precision power analyzer. Designed to provide clear and accurate measurements of electrical power and energy on all electrical products, the PM1000+ is both an easy to use bench instrument and a fast and programmable automatic test interface.

Basic Features:

- Measures Watts, Volts, Amps, Volt-Amperes and Power Factor.
Always accurate, even on distorted waveforms.
- Range of measurement from milli-watts to mega-watts.
- Built-in energy analyzer (watt-hour integrator) for measuring energy consumption over time.
- Standby power measurement mode for fast and accurate low power measurements.
- Harmonic analyzer with built in spectrum display
- Bright color display
- Comprehensive range of computer interfaces including RS232, and USB and parallel printing (basic comms model).
- Inrush current measurement mode for measuring switch-on and other transient peak currents.
- Ballast mode for measuring the tube power of electronic ballasts.
- Easy-to-use menu system with context-sensitive help.

In addition, the standard comms model includes GPIB (IEEE 488.2).

The enhanced comms model also includes USB host for printer and data logging support.

1.2. PACKAGE CONTENTS

The following items are supplied with your PM1000+.

Please check that you have every item and report any missing items to your Voltech supplier as soon as possible

- PM1000+ Power Analyzer (Basic or Enhanced Communications)
- Certificate of Conformance and Calibration
- CD including user's manual and calibration data
- Mains power cable
- 2 pairs of yellow and black measuring leads

1.3. ACCESSORIES

Please see our website at www.voltech.com for accessories available from Voltech and other suppliers. These include:

Spare measuring lead set (part number 78-124)

- A range of current transformers to extend the measuring range from <math><1\text{mA}</math> to 3000A
- Connectors for the 2mm external shunt input
Part numbers 78-128 (red) and 78-129 (black).
- Communications leads (RS232, USB...)

2. QUICK START

2.1. POWER ON

1. Check the power analyser is in good condition with no signs of damage.
2. Connect the line power supply cable.
3. Ensure the supply is Earth grounded.
4. Press the power switch at the front to on (I)

The PM1000+ will start its power up sequence. This takes 5-10 seconds.

During power up you will see the PM1000+'s serial number and last adjustment date.

5. The instrument is now ready for use



2.2. CONNECTING TO THE PRODUCT UNDER TEST

The PM1000+ will measure up to 600Vrms and 20Arms directly using the 4mm terminals on the front panel. For measurements outside the range (low or high power) see the section on Using Current and Voltage Transducers later in this manual.

To measure power, connect the PM1000+'s measuring terminals in parallel with the supply voltage and in series with the load current.



Always use good quality safety cables as supplied and check that they are not damaged before use.

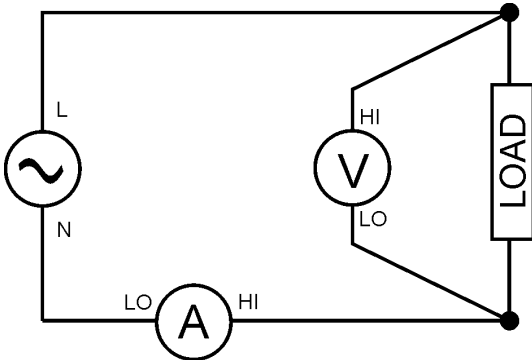

V HI **V LO**
To ac supply live To load neutral

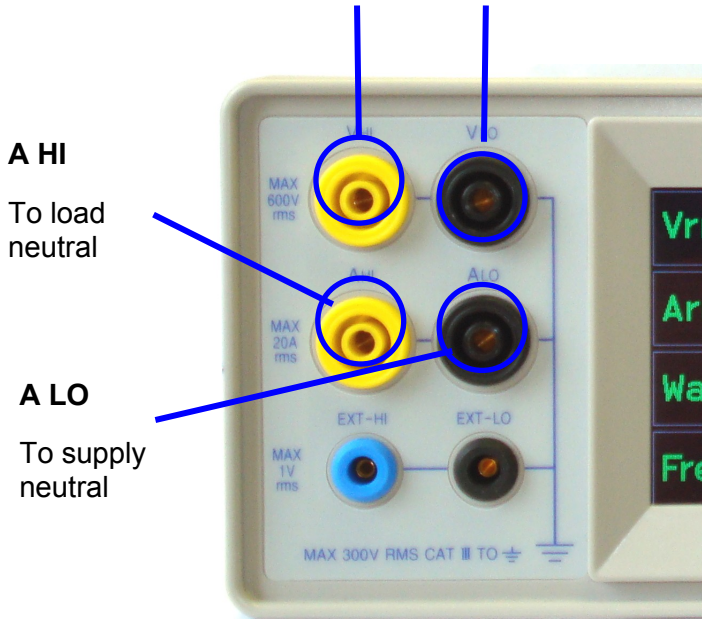

The simplest and safest way to make a connection to the product under test is to use a Voltech Break Out Box. This provides a line socket for connection of the product and 4 x 4mm sockets for direct connection to the PM1000+ terminals as described above.





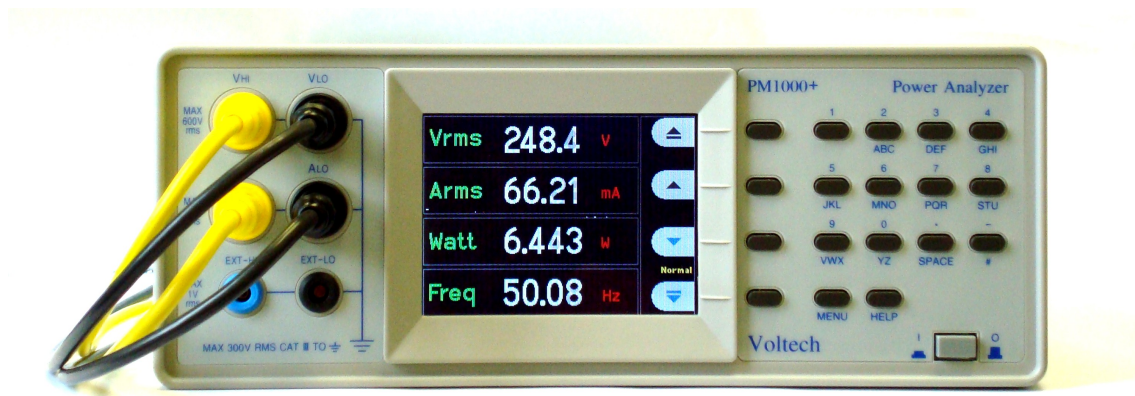

2.3. DEFAULT MEASUREMENTS

Switch on the supply to the load and the PM1000+ is now ready to make measurements. Note that it is not necessary to switch the PM1000+ either off or on when the load is being connected.



The default display shows 4 values. Each line clearly shows the measurement type 'Vrms', the measured value, '248.4' and the measurement units, 'V'. Normal engineering notation is used to describe units, e.g. mV = milli-volts (10^{-3}) and MV = mega-watts (10^{+3}).

To scroll through the measurements, use the 4 keys to the right of the display:

	Jump Up	Display the page above.
	Up	Move up through the measurement list.
	Down	Move down through the measurement list.
	Jump Down	Display the page below.

2.4. NAVIGATING THE MENU SYSTEM

The menu system provides complete access to all settings of the PM1000+. To access the menu system, press the MENU key.







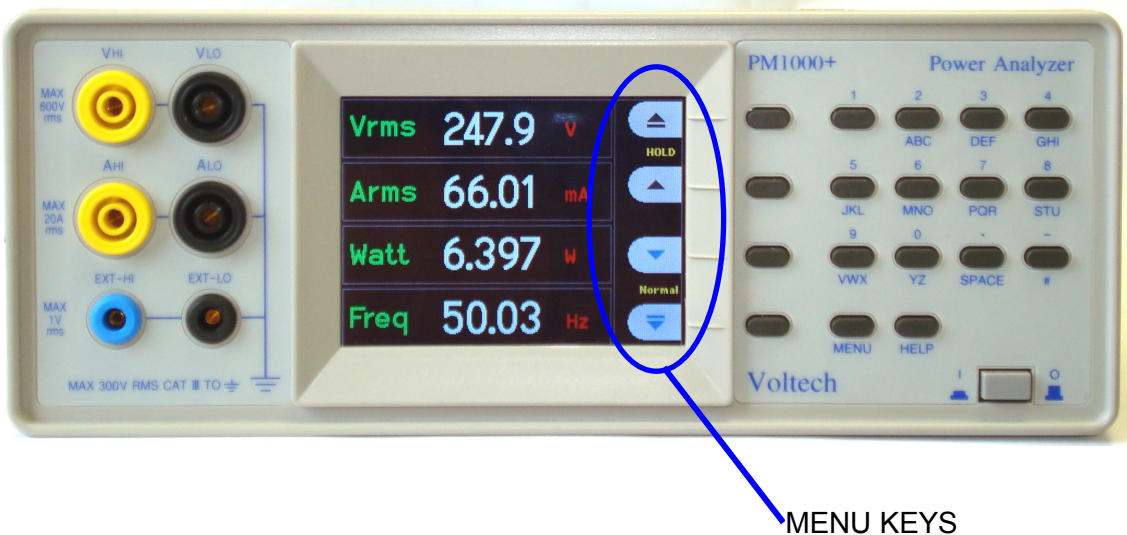



To return to the measurement display at any time, simply press the MENU key again.

With the menu system active, the 4 soft keys to the right of the display may be used to navigate and select options.









2.5. MENU KEYS

	Up	Move up through the list of displayed options
	Down	Move down through the list of displayed options
	Up	Accept or switch on the option shown
	Down	Decline or switch off the option shown
	Up menu	Go up to a higher menu level
	Down menu	Go down to a lower, more detailed, menu
	Delete	Delete the character to the left.
	OK	Accept entered data.

2.6. EXAMPLE: CHOOSING MEASUREMENTS TO DISPLAY

To choose the measurements on the display:

1. press MENU (to show the menu)
2. press  (to see the list of Measurements)
Measurements with a  will be displayed in the order shown.
3. Select   the measurement to display and press .
4. (Option). Move the measurement  
5. Press **OK**.

To remove a measurement, select it and press 

Hint:

To restore the default list, see the User Configuration Menu.

2.7. KEY SHORTCUTS

Display freeze:	Press SPACE
Display graph:	Press YZ
Print:	Press VWX
Local control (from remote):	Press #
Toggle Data Logging:	Press STU or 1

2.8. PRINTING

The PM1000+ can print to a parallel port, RS232 serial port, or, on the enhanced comms version, to a USB printer. To configure where printing is sent, see the Interfaces section (4.8) of this manual.

Due to the increasing variety and proprietary nature of printer standards the PM1000+ will not support all printers. The below listed printers have been tested as shown and work with the PM1000+.

	Parallel	USB	Serial/RS232
Epson LQ 570+	Yes	NA	NA
HP Deskjet 5652	Yes	Yes	NA
HP Deskjet 930C	Yes	No	NA
Seiko DPU 414	Yes	NA	NA
Lexmark E240n	Yes	Yes	NA
Citizen (Seiko) iDP562-CNL	Yes	NA	NA
Axiohm ASTER5530/A	NA	NA	Yes

Printers Tested w/ the PM1000+

To send results to a printer, press the "VWX" key on the front panel. All the currently selected results will be printed to the currently selected printer.

2.9. DATA LOGGING

An Enhanced Comms version of the PM1000+ can be enabled to log data to a USB flash drive. The unit will log all selected measurements into a comma separated value (CSV) formatted file that is stored on the connected USB flash drive. Results will be logged once per second.

Prior to enabling data logging, insert a USB flash drive into the USB host port on the rear of the PM1000+.

Data logging is not available on Basic Comms versions of the PM1000+.

Warning: If the USB flash drive is removed while data logging is enabled, data corruption will occur.

Logging Data:

To start data logging press the 8/STU key or the 1 key on the PM1000+ keypad. Data logging will be indicating by the text indicating the current mode flashing every second. To stop data logging press the 8/STU key or the 1 key on the PM1000+ keypad.

Data Storage and Format:

The data will be logged in a directory created by the PM1000+ on the USB flash drive. The directory structure created will contain the last five digits of the serial number of the PM1000+ used and the date at the start of data logging. The file name will reflect the time at the start of data logging in 24hr format and will have a .CSV extension.

For example, if a PM1000+ with the serial number 100008200001 begins data logging on 29 February 2008 at 2:18:56PM, the directory tree will be as shown below.

```
Root Dir\PM1000+\00001\20080229\14-18-56.csv
```

The first portion of the file will contain a header identifying the instrument used by serial number and the time data logging began. The second portion of the file will contain column headers for every measurement currently selected. Subsequent lines will contain an indexed set of the measurements currently selected, in the order displayed on the PM1000+ screen. The basic format of the data is shown below. Time and date will be in 24hr and year, month, day (YYYYMMDD) format respectively.

Voltech Instruments PM1000+

Serial Number: 100008200001
Firmware Version 4.13RC4
Start Date (YYYYMMDD): 10/30/2008
Start Time (24hr): 8:00:33

Index	Vrms	Arms	Watt	Freq	PF
1	2.09E-01	2.90E-03	1.83E-04	0	3.02E-01
2	2.08E-01	2.90E-03	1.83E-04	0	3.03E-01
3	2.08E-01	2.91E-03	1.82E-04	0	3.01E-01
4	2.08E-01	2.90E-03	1.83E-04	0	3.02E-01

USB Flash Drive Requirements:

- The USB flash drive must be formatted with FAT12, FAT16 or FAT32 file systems.
- Sector size must be 512 bytes. Cluster size up to 32kB.
- Only Bulk Only Mass Storage (BOMS) devices which support the SCSI or AT command sets are supported. For more information on BOMS devices refer to *Universal Serial Bus Mass Storage Class – Bulk Only Transport Rev. 1.0*, published by the USB Implementers Forum.

2.10. UNIT CONFIGURATION

To view unit configuration data including hardware revision, firmware revision, serial number, date and type of last adjustment, and whether IEC mode has been enabled, using the menu system, select:

System Configuration → Unit Configuration

Explanation of Adjustment Type

The following descriptions are possible for adjustment type.

Adjustment Type	Explanation
None	No adjustment applied.
Limited	Adjustment of limited range of magnitude and frequency.
Full	Full adjustment to specifications (see Section 7.5).
Full Enhanced	Full adjustment to enhanced specification (see Section 7.5).

To receive a Full Enhanced adjustment the unit must be sent back to Voltech Instruments.

3. USING VOLTAGE AND CURRENT TRANSDUCERS

3.1. INPUT OVERVIEW

Voltage

Voltages of up to 600V rms may be connected directly to the black and yellow 4mm VHI and VLO safety sockets at the front of the PM1000+

Current

Currents of up to 20A rms may be connected directly to the black and yellow 4mm AHI and ALO safety sockets at the front of the PM1000+

External Current Inputs

The external current inputs accept a voltage of up to 1V rms that is proportional to the current being measured. This input allows a very wide range of external current transducers to be connected, from low mA current shunts to MA current transformers. For each type of transducer, the PM1000+ may be scaled to read the correct current. See the INPUTS menu.

The choice of current transducer will depend on:

- The current being measured, including peaks and transients.
- The accuracy required.
- The bandwidth required: Unless the waveforms are purely sinusoidal, a bandwidth in excess of the fundamental frequency will be required.
- Whether there is DC current present.
- Convenience of connection – E.g. using a clamp-on current transformer, with jaws that open, for quick connection in a fixed wiring loom.
- The effect of the transducer on the circuit.

3.2. TO CONNECT A SIMPLE CURRENT TRANSFORMER

To use a conventional current transformer (CT) like the Voltech CL series (or any other transducer with a current output), connect the normal AHI and ALO inputs of the PM1000+ to the outputs of the current transformer. Follow the manufacturer's instructions for the safe use and installation of the transducer.

Normally the positive or HI output of the transducer will be marked with the point of an arrow or a '+' symbol. Connect this terminal to the AHI input of the PM1000+.

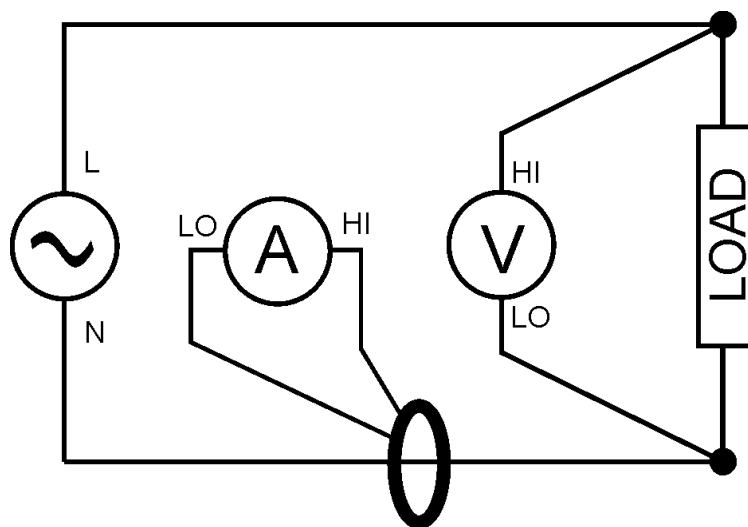

Current Scaling.

A current transformer produces an output current that is proportional to the load current being measured. For example, the Voltech CL100 produces an output current that is 1/100 of the current being measured.

To measure the correct current on the PM1000+, use the scale function of the analyzer to scale, or multiply, the CT output current.

For example, the CL100 is a 100:1 CT. When measuring 100A, its output is 1A. To scale this on the PM1000+, a scale factor of 100 must be entered:

Press 'MENU'

Select ▲▼ 'Inputs' and press ►

Select ▲▼ 'Scaling' and press ►

Use the  delete key to clear the entry.

Type the new scale factor (100)

Press **OK**

Press 'MENU' to return to the measurement display.

The PM1000+ is now ready to make measurements using a CT.

3.3. TO CONNECT AN EXTERNAL RESISTIVE SHUNT:

Using resistive shunt is a straightforward method of extending the current measuring range of the PM1000+. The shunt resistor is connected in series with the load and the voltage across the shunt is directly proportional to current.

That voltage may be connected directly to the External Current Inputs of the PM1000+.

For example, a 1milli-ohm shunt is to be used to measure 200A rms.

1. Check the voltage that will be generated is suitable for the PM1000+

$$V = I \times R \text{ (Ohm's law)}$$

$$V_{\text{shunt}} = I \times R_{\text{shunt}}$$

$$V_{\text{shunt}} = 200 \times 0.001 \text{ Ohms}$$

$$V_{\text{shunt}} = 0.2V$$

This is well within the 1V rating of the PM1000+'s External Current Inputs

2. Connect the shunt in series with the load and to the EXT-HI and EXT-LO inputs as shown.

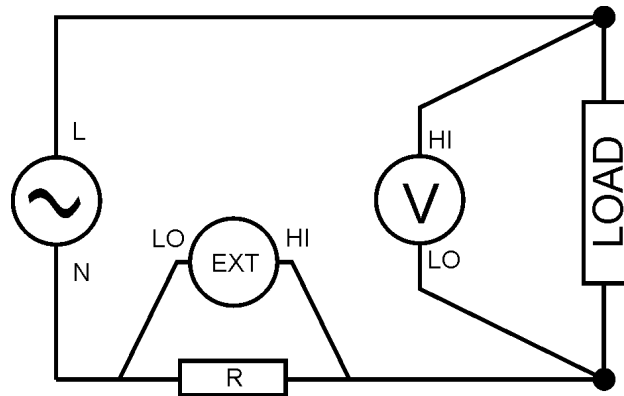

REMOVE ANY CONNECTIONS TO THE NORMAL ALO TERMINAL!
EXT-LO and ALO are connected inside the PM1000+. To avoid errors and a risk of electric shock, remove all connections to ALO.

3. Set up the PM1000+ to measure current from the EXT-HI and EXT-LO terminals.

Press 'MENU'

Select ▲▼ 'Inputs' and press ►

Select ▲▼ 'Shunts' and press ►

Select ▲▼ 'External' and press ✓

Press 'MENU' to return to the measurement display.

4. Scale the measurement on the display.

The default scale is 1V = 80A.

The scale required for any external shunt is given by:

$$\text{Scale} = 1 / (80 \times R)$$

(where R is the resistance value of the external shunt).

In this example where R = 0.001 Ohms

$$\text{Scale} = 1 / (80 \times 0.001)$$

$$\text{Scale} = 1 / 0.08 = 12.5$$

To enter a scale factor for current:

Press 'MENU'

Select ▲▼ 'Inputs' and press ►

Select ▲▼ 'Scaling' and press ►

Select ▲▼ 'Amps' and press ►

Use the  delete key to clear the entry.

Type the new scale factor (e.g.10)

Press **OK**







Press 'MENU' to return to the measurement display.

The PM1000+ is now ready to make measurements using an external shunt.

3.4. TO CONNECT A TRANSDUCER WITH A VOLTAGE OUTPUT

These transducers contain active circuits that help to improve performance at high bandwidth. They may be of the 'hall effect' or Rogowski coil type.

The procedure is similar to that of installing an external shunt as described above.

1. Follow the manufacturer's instructions for the safe use and installation of the transducer.
2. Connect the voltage output to the EXT-HI and EXT-LO terminals of the PM1000+ channel as above.
3. Select 'Inputs' – 'Shunts' – 'External' as above.
Press 'MENU'
Select  'Inputs' and press 
Select  'Shunts' and press 
Select  'External' and press 
Press 'MENU' to return to the measurement display.
4. Select and input a scale factor. These types of transducers are often rated in terms of mV / amp. For example a transducer with an output of 100mV / amp is the equivalent of a 100 milli-ohm external shunt resistor.

Scale = $1 / (100 \times R)$ (where R is the resistance value of the shunt).

In this example where R = 0.1 Ohms

$$\text{Scale} = 1 / (100 \times 0.1)$$

$$\text{Scale} = 1 / 10 = 0.1$$

Press 'MENU'

Select  'Inputs' and press 

Select  'Scaling' and press 

Select  'Amps' and press 

Use the  delete key to clear the entry.

Type the new scale factor (e.g. 0.1)

Press **OK**

5. Press 'MENU' to return to the measurement display.

The PM1000+ is now ready to make measurements using a current transducer with a voltage output.

3.5. TO CONNECT A VOLTAGE TRANSFORMER / TRANSDUCER

The PM1000+ may be used with a voltage transformer (VT) or other transducer to extend its measuring range. Follow the manufacturer's instructions for the safe use and installation of the transducer.

The output of the transducer is connected to the normal VHI and VLO terminals. Normally the positive or HI output of the transducer will be marked with the point of an arrow or a '+' symbol. Connect this terminal to the VHI input of the PM1000+.

Voltage Scaling.

A voltage transformer (VT) produces a voltage output which is proportional to the voltage being measured.

To measure the correct voltage on the PM1000+, use the scale function of the analyzer to scale, or multiply, the VT output current.

For example, when measuring with a 1000:1 VT a scale factor of 1000 must be used.

Press 'MENU'

Select ▲▼ 'Inputs' and press ►

Select ▲▼ 'Scaling' and press ►

Select ▲▼ 'Volts' and press ►

Use the  delete key to clear the entry.

Type the new scale factor (100)

Press **OK**

Press 'MENU' to return to the measurement display.

The PM1000+ is now ready to make measurements using a VT.

4. THE MENU SYSTEM

4.1. NAVIGATION

The PM1000+'s menu is a powerful yet easy-to-use system for control of the analyzer. See the 'Quick Start' section of this manual for an overview of how to access and use the menu system.

For help at any time whilst using the PM1000+ press the HELP key at any time.

4.2. MENU ITEMS

To switch the display of the menu system off or on, press the 'MENU' key at any time.

4.3. MAIN MENU

To select a menu, press ►.

4.4. MEASUREMENTS.

Choose the measurements to display.

To add a new measurement:

1. Select it ▲▼ and press ✓.
2. (Option). Move the measurement ▲▼ (does not apply to harmonics)
3. Press OK.

To remove a measurement, select it and press X

Hint:

To restore the default list, see the User Configuration Menu.

For information on setup for harmonics and distortion factor, see section 4.10 System Configuration.

4.5. MODES.

Special application modes.

Select Mode

Choose this option to set the PM1000+ into one of its operating modes. Each mode is indicated on the front panel measurement display once set.

The modes are:

Normal – Ideal for most general measurements.

Ballast – For measuring the output of electronic ballasts. See www.voltech.com for application notes on this subject. The frequency displayed is the ballast switching frequency.

Inrush – For measuring the peak current during any event. Typically this is used to measure the peak current when a product is switched on.

Standby Power – A special mode in the analyzer that allows the user to set a time window over which to accumulate power measurements. When set, power measurements will update after each time window period, other available measurements will update at the normal display update rate of 0.5 seconds. The currently displayed power measurement represents the amount of power accumulated over the last time window only.

Integrator – For energy consumption (W-h) measurements over time. Ideal for rating products whose energy consumption is not constant like washing machines and refrigerators.

IEC Current Harmonics – This mode is control via PC software. It enables pre-compliant current harmonic measurements to IEC 61000-3-2 to be made. This mode is optional on the PM1000+. Please visit www.voltech.com for more information.

IEC Voltage Flicker – This mode is control via PC software. It enables pre-compliant Pst measurements to be made as described in IEC 61000-3-3. Please visit www.voltech.com for more information.

Notes on Change Mode

When you change mode, the measurements (see 4.4) displayed will changed. Adding a measurement to the display will only apply to the currently selected mode. The number of available measurements (see 4.4) are different depending

on which mode you are in. The same applies for remote communications since the "FRD?" command, which is used to return results, only returns the results displayed on the screen, in the order in which they are displayed.

The table below lists which measurements are available in which mode, along with which measurements are displayed by default for the selected mode:

Measurement	Mode				
	Normal	Ballast	Inrush	Standby Power	Integrator
Vrms	✓*	✓*	✓	✓*	✓*
Arms	✓*	✓*		✓*	✓*
Watts	✓*	✓*		✓*	✓
VA	✓	✓		✓	✓
Var	✓	✓		✓	✓
Freq	✓*	✓*	✓	✓*	✓*
PF	✓*	✓*		✓*	✓*
Vpk+	✓	✓	✓*		
Vpk-	✓	✓	✓*		
Apk+	✓	✓	✓*		
Apk-	✓	✓	✓*		
Vdc	✓	✓			
Adc	✓	✓			
Vcf	✓	✓		✓	
Acf	✓	✓			
Vthd	✓	✓		✓	
Athd	✓	✓			
Z	✓				
R	✓				
X	✓				
Hr					✓
Whr					✓*
VAHrs					✓
VArHr					✓
Ahr					✓
V-harm	✓	✓		✓	
A-harm	✓	✓			
V range	✓	✓	✓	✓	✓
A range	✓	✓	✓	✓	✓

✓ = Measurement available

* = Displayed as default

Also, depending on which mode you change to, other settings may be changed.

The changes are listed below:

- When you change to all modes, except Inrush mode, the voltage and the current ranges will be set to auto.

- When you change to Inrush mode the voltage and current ranges will be set to the defaults set up under the Inrush mode setup

Setup Mode

Choose the mode that you want to setup.

Ballast Setup - The ballast mode is fully automatic and no setup is required.

In ballast mode, the PM1000+ automatically makes measurements that are synchronized to 50, 60 or 400Hz line inputs and simultaneously measures the switching high frequency output.

Inrush Setup - Choose the default starting current range and the default starting voltage range. Start with the maximum range and then set the mode and make measurements. Choose a lower range with the soft-keys for more accuracy once you begin to make measurements.

Standby Power Setup - The time window is the time over which the PM1000+ will average the samples. Note that the measurements will only update at the period specified in the time window, with the exception of Vrms, Vcf, Frequency, Vthd, and Vharmonics magnitude and phase which will continue to update every 0.5 seconds.

See the technical notes at www.voltech.com for more information on standby power including the articles "Why Measure Low Standby Power?", "Standby & Low Power Measurements" and "Standby Power to IEC62301".

Integrator Setup - The Integrator on the PM1000+ operates in two methods, the Manual Start Method and the Clock Start Method.

In the Manual Start Method the integrator will start and stop when the user presses the start/stop button and will reset when the user presses the reset button.

In the Clock Start Method the PM1000+ will use its real time clock to start the integrator based on the date and time set up by the user. The user will also configure a duration for the Clock Start Method that will stop the integrator at the appropriate time.

The desired Start Method is configured in the Integrator Setup, Start Method menu. Select Manual or Clock using the ✓ key.

If Manual Start Method is selected, nothing more needs to be configured to run the integrator. After the mode is selected, the user will use the start/stop (●/●) key to start and stop the integrator and the reset key (↺) to reset the accumulated values.

Note: Use of the reset key (↺) requires the integrator to be stopped.

The Clock Start Method is configured in the Integrator Setup menu. Here the user can configure the start date and time and the duration. The starting time and the starting date are entered in the current format of the PM1000+, as shown at the time they are entered. The duration is entered in minutes in the range shown on the data entry screen.

4.6. INPUTS.

Set up the measurement inputs – range, scale and low value blanking.

This menu may be used to set up the physical inputs of the PM1000. For normal operation 20mA to 20A and up to 600V it is not necessary to change these settings from default.

To select an Inputs menu item, use the ▲▼ keys and then press ► for detailed options.

Fixed/Auto Ranging

For most measurements, auto-ranging is the best choice. Choosing a fixed range may be useful if the voltage or current is changing continuously or has large peaks that make the analyzer spend excessive time changing range.

Select ▲▼ Volts or Amps and press ► to choose the range.

Changing the measurement mode (4.5) will often reset the voltage and current range to auto.

Scaling

When the 600 V and 30A inputs are used directly then the scaling for Volts and Amps is 1, which is the default setting.

To use the PM1000+ with external voltage or current transducers, enter a scale factor to have the PM1000+ display the true, scaled measurements.

Select ▲▼ Volts or Amps and press ► to enter the scale factor.

See the Chapter 'Using External Voltage and Current Transducers' for further information.

Frequency Source

To make accurate rms measurements the PM1000+ must first determine frequency. Normally the PM1000+ detects frequency from the voltage signal using proprietary algorithms.

If no voltage signal is present, or it is a chopped waveform, then it may be necessary to select Amps as the frequency source.

Select Volts or Amps Frequency Source using the ▲▼ keys and press ✓ to confirm.

Frequency Filter

For optimal frequency measurement performance when measuring voltage signals below 20kHz, the Low Pass frequency filter can be engaged. If the signal level on the voltage signal is less than 10% of range and the frequency is known to be less than 20kHz, the Low Pass frequency filter is recommended.

Select Auto or Low Pass using the ▲▼ keys and press ✓ to confirm.

Shunts

The internal shunt of the PM1000+ is suitable for measurements in the range 20mA to 20A rms and this may be extended by the use of suitable current transducers from uA to MA.

Some current transducers (including simple resistive shunts) produce a voltage that is proportional to current. External Shunt Inputs are provided on the PM1000+ for use with current transducers that provide a voltage output.

Because the 0V is common to both the internal and external shunts, only one type may be connected at any time.

Select Internal or External Shunt using the ▲▼ keys and press ✓ to confirm.

See the Chapter 'Using External Voltage and Current Transducers' for further information.

Blanking

Normally enabled, select Disable to measure voltage or current that is small (<0.25V or <3mA). If blanking operates on either voltage or current then all related measurements would be blanked including W, VA and PF.

Select Disable or Enable using the ▲▼ keys and press ✓ to confirm.

Averaging

Normally disabled, select Enable to allow the PM1000+ to average results. Averaging depth is set at four when enabled. All results, including harmonic magnitude and phase, are averaged except for ranges (when selected for display) and cumulative measurements (Whrs, Vahrs, VAr_hrs, Ahrs, and Hrs).

Select Disable or Enable using the ▲▼ keys and press ✓ to confirm.

4.7. GRAPHS.

Set up the graphical displays of the PM1000+

Select the graph type using the ▲▼ keys and press ► for options.

HINT: Use the 'YZ' key to toggle between graphic and numeric displays.

Waveform Graph

This will display the voltage, current and (optionally) the watts waveform.

The scale of the graph is set automatically according to the selected range and scaling. Display of the Watts graph may be disabled.

Select ▲▼ Show and press ✓ to display the Waveform Graph.

Select 'Watts' to add the instantaneous watts waveform to the display.

NOTE: Waveforms will only be displayed when there is a valid frequency. DC waveforms will not be displayed.

Harmonic Bar Chart

Select Voltage or Current harmonic bar chart using the ▲▼ keys and press ► for details.

The 'scale' is the maximum amplitude that will be displayed. Set the scale to be similar to the rms value to see an overview of the spectrum. To view smaller harmonics in more detail a smaller 'scale' may be set.

If the harmonic exceeds the set scale it will be shown with a white cap on the top of the bar.

The 'scale' only applies when the harmonic format is absolute measurements. If percentage measurements are used, then the scale is automatically set to 100%. The fundamental harmonic (H1) will be displayed as 100%.



The right \Rightarrow and left \Leftarrow arrow keys may be used to select the harmonic whose amplitude and phase are shown at the top of the screen. The selected harmonic is shown in yellow. 

Select $\blacktriangle\blacktriangledown$ Show and press \checkmark to display the harmonic bar chart (voltage or current).

Integration Graph

Select Integration graph using the $\blacktriangle\blacktriangledown$ keys, press \blacktriangleright to configure.

The Integration Graph menu allows the user to select what value to display on the graph, the vertical scale of the graph (in units of the value selected), and the horizontal scale (duration) of the graph.

The horizontal scale of the graph is only for display purposes. The integration will continue until stopped by the user using the start/stop (/) button.

When the graph is configured, select Show to view the graph.

Note: The PM1000+ must be in Integrator mode for the graph to start.

4.8. INTERFACES.

This menu may be used to set up the interfaces of the PM1000+

To select set up an interface, use the $\blacktriangle\blacktriangledown$ keys and then press \blacktriangleright for detailed options.

RS232 Baud Rate

Select $\blacktriangle\blacktriangledown$ the desired baud rate and press \checkmark to confirm.

9600, 19200 (default) and 38400 are available.

The PM1000+ uses hardware handshaking (RTS / CTS) with no parity, 8 data bits and 1 stop bit (N,8,1).

The RS232 baud rate is unchanged after a "*RST" or ":DVC" command.

GPIB Address

Enter the GPIB address and press **OK**.

Default address is 6. The address is unchanged after a “*RST” or “:DVC” command.

Printer Select

An Enhanced Comms version of the PM1000+ can select between a traditional 25-pin printer port, a USB printer port or a RS232 printer port. Select ▲▼ the desired printer interface and press ✓ to confirm.

The USB printer port is not available on the Basic Comms version of the PM1000+.

The baud rate for the RS232 printer port is set in the RS232 Baud Rate menu as described above.

RS232 printing is implemented with no flow control.

The selected print port is unchanged after a “*RST” or “:DVC” command.

Ethernet Configure

The Enhanced Comms version of the PM1000+ offers Ethernet communications through a standard Ethernet port using TCP/IP.

The Ethernet port will make a TCP/IP connection on port 5025. Port 5025 is designated by the Internet Assigned Numbers Authority (IANA) to be a SCPI port.

Use the IP Selection Method menu, and the ▲▼ keys, to opt for a dynamically assigned IP address, by selecting “Set IP using DHCP”, or a fixed/static IP address by selecting “Fix IP Address” with the ✓ button.

To view the current IP settings, choose “Current IP Settings” in the Ethernet Setup menu. This allows the user to view the current IP address, subnet mask, and default gateway.

To configure the static IP address, choose “Static IP Settings” in the Ethernet Setup menu. This allows entry of the IP address, the subnet mask and the default gateway. After entering the relevant data press the **OK** button, in each menu, to apply.

Ethernet communications are not available on the Basic Comms version of the PM1000+.

For basic communication needs via TCP/IP the user can try the Agilent Connection Expert contained in the [Agilent IO Libraries Suite 15.0](#).

The Ethernet mode (Static/DHCP), IP address, default gateway and subnet mask are unchanged after a “*RST” or “:DVC” command.

4.9. SYSTEM CONFIGURATION.

Set up harmonics, distortion, the clock and auto zero.

To select a menu item, use the ▲▼ keys and then press ► for detailed options.

Harmonics Setup

For both voltage and current harmonics, a number of different parameters can be set. These settings are independent of the mode that is currently selected.

- Sequence: All or odd harmonics only
- Range: The maximum harmonic (up to 50)
- Format: Display harmonics as absolute values or as a percentage of the fundamental (1st) harmonic.

Distortion Setup

For both voltage and current harmonics, a number of different parameters can be set. These settings are independent of the mode that is currently selected.

For following settings can be made for distortion.

- Formula: Series or difference (default = series formula)
- Sequence: Include all harmonics or only odd harmonics in the series formula. (default = all harmonics)
- Range: The maximum harmonic to be included in the series formula. (default = 7)
- DC (H0): Include or exclude DC in the series formula. (default = exclude)
- Reference: rms or 1st harmonic. (default = rms)

See section 6.4 for details of the actual equations used.

Auto Zero

Normally the PM1000+ will cancel any small dc offsets in the measurement automatically. This is called Auto Zero.

Auto Zero should always be enabled.

Select ▲▼ Disable and Enable and press ✓ to confirm.

Clock Setup

These options may be used to check or set the PM1000+'s internal clock.

To select a menu item, use the ▲▼ keys and then press ► for detailed options.

Set Time - Enter the time using the format shown and press **OK** to confirm.

Set Date - Enter the date using the format shown and press **OK** to confirm.

Time Format - Select ▲▼ 12 Hour or 24 Hour and press ✓ to confirm.

Date Format - Select ▲▼ the required date format and press ✓ to confirm.

Unit Configuration

For units with firmware version 4.13 or later, the Unit Configuration menu displays the hardware revision, firmware revision, serial number, date and type of last adjustment and whether IEC mode has been enabled. To meet the enhanced specification for 45-65Hz, the adjustment type must be "enhanced".

IEC Key Code Entry

This is used to enable the IEC Pre-Compliance PC software. After the software has been enabled, this menu item will be disabled.

The status of the IEC Pre-Compliance Software (Enabled or Disabled) can be viewed in the Unit Configuration menu.

4.10. USER CONFIGURATION.

Save and recall your set up.

To select a menu item, use the ▲▼ keys and then press ► for detailed options.

The first option is to 'Load Default'. Choosing this option will set every menu option of the PM1000+ to its factory default.

The other menu items (Default 'CONFIGURATION n') may be used to store and recall all settings of the PM1000+

For each User Configuration, you may:

Apply – apply the saved configuration.

Rename – give the configuration a meaningful name.

Save Current – save a configuration. This is always the complete setting, including the communication settings, of the PM1000+ at the time you choose this option.

Print – Print the configuration.

4.11. VIEW.

Set up zoom and contrast.

To select a menu item, use the ▲▼ keys and then press ► for detailed options.

Zoom

Select ▲▼ either 4 results or 14 results display and press ✓ to confirm.

Contrast

Enter a contrast number and press OK to confirm.

50 is the default value.

5. REMOTE OPERATION

5.1. OVERVIEW

Using the remote commands the PM1000+ can be used to perform high speed, complex or repetitive measurements.

5.2. COMMAND LISTING

Commands may be in upper or lower case.

Please see the next section for examples.

"*CLS"	Clears Standard Event Status Enable Register (ESE) and Data Status Register (DSR).
"*ESE <value>"	Sets the Standard Event Status Enable Register (ESE). The <value> sent is a decimal value.
"*ESE?"	Returns the value stored in the Standard Event Status Enable Register (ESE) as decimal value.
"*ESR?"	Returns the Standard Event Status Register (ESR) as decimal value.
"*IDN?"	Returns the product ID string.
"*RST"	Resets the unit to default settings. This command leaves communication settings unchanged.
"*STB?"	Returns the Status Byte Register (STB) as a decimal value.
":AVG <value>"	Enable or disable averaging of results (averaging depth of 4). <value> = 0 → Disable (default) <value> = 1 → Enable
":AVG?"	Returns status of averaging of results. 0 → Disabled (default) 1 → Enabled

":BLK:ENB"	Enables blanking
":BLK:DIS"	Disables blanking
":BLK?"	Returns current blanking setting. 0 → Disabled 1 → Enabled (default)
":CAL:DATE?"	Returns the date of last calibration.
":CFG:LOAD <value>"	Loads requested configuration <value>= 0 to 5, 0 = default.
":CFG:SAVE <value>"	Saves the specified configuration <value>= 1 through 5.
":CFG:PRINT <value>"	Prints the specified configuration <value>= 1 through 5.
":COM:RS2:BAUD <value>"	Sets the RS232 baud rate <value> = 9600, 19200 or 38400
":COM:RS2:BAUD?"	Returns the current baud rate setting
":COM:IEE:ADDR <value>"	Sets the IEEE488 (GPIB) address <value> = 1 - 30
":COM:IEE:ADDR?"	Returns the current IEEE488 (GPIB) address setting
":COM:ETH:GATE?"	Returns Default Gateway currently in use.
":COM:ETH:IP?"	Returns the IP address currently in use.
":COM:ETH:SUB?"	Returns Subnet Mask currently in use.
":COM:ETH:MAC <value>"	Will set the MAC address. Accepts the lower 24 bits as ASCII hex string. Ex. <value> = 5AB2F1.
":COM:ETH:MAC?"	Returns Ethernet MAC address to the user in hex string format.
":COM:ETH:STAT <value>"	Sets way in which IP address is obtained. <value> = 0 → DHCP <value> = 1 → Static IP settings
":COM:ETH:STAT:GATE xxx.xxx.xxx.xxx"	Sets the static default gateway.
":COM:ETH:STAT:GATE?"	Returns the stored static Default Gateway.
":COM:ETH:STAT:IP xxx.xxx.xxx.xxx"	Sets the static IP address.
":COM:ETH:STAT:IP?"	Returns the stored static IP address.
":COM:ETH:STAT:SUB xxx.xxx.xxx.xxx"	Sets the static subnet mask.
":COM:ETH:STAT:SUB?"	Returns the stored static Subnet Mask.
":COM:ETH:STAT?"	Returns the status of Static IP enabled flag to the user. 0 -> DHCP, 1 -> Static.

":DSE <value>"	Sets the Data Status Enable Register (DSE). The <value> sent is a decimal value.
":DSE?"	Returns the Data Status Enable Register (DSE) as decimal value.
":DSR?"	Returns the Data Status Register (DSR) as decimal value.
":DVC"	Device clear. Sets device to default settings. This command leaves communication settings unchanged.
":FRD?"	Returns the selected values
":FRF?"	Returns the current selection list
":FSR:VLT"	Sets the frequency source for voltage
":FSR:AMP"	Sets the frequency source for current
":FSR?"	Returns the freq source 0 = volts 1 = amps
":GRA:HRM:VLT:SCL <value>"	Set scaling in harmonic bar chart for Volts <value> = 0 - 1000
":GRA:HRM:AMP:SCL<value>"	Set scaling in harmonic bar chart for Amps <value> = 0 - 100
":GRA:HRM:AMP:SHW"	Show current bar chart
":GRA:HRM:VLT:SHW"	Show voltage bar chart
":GRA:HRM:HLT"	Highlights required harmonic "value" = 1 through 50
":GRA:WAV:WAT <value>"	<value> = 0 → Watts graph disabled <value> = 1 → Watts graph enabled
":GRA:WAV:SHW"	Show waveform graph
":HMX:VLT:SEQ <value>"	Sets odd or odd/even harmonics: <value> = 0 → odd/even <value> = 1 → odd only
":HMX:VLT:RNG <value>"	Sets harmonic range <value> = 1 - 50
":HMX:VLT:FOR <value>"	Sets voltage harmonic format: <value> = 0 → Absolute values <value> = 1 → Percentage of fundamental
":HMX:AMP:SEQ <value>"	Sets odd or odd/even harmonics: <value> = 0 → odd/even <value> = 1 → odd only

":HMX:AMP:RNG <value>"	Sets harmonic range <value> = 1 - 50
":HMX:AMP:FOR <value>"	Sets current harmonic format: <value> = 0 → Absolute values
":HMX:THD:FML <value>"	<value> = 1 → Percentage of fundamental Select the THD formula : <value> = 0 → series
":HMX:THD:SEQ <value>"	<value> = 1 → difference Select the THD sequence: <value> = 0 → All
":HMX:THD:RNG <value>"	<value> = 1 → odd only Set the THD range <value> = 2 to 50.
":HMX:THD:HZ <value>"	Choose to include or exclude THD Harmonic zero: <value> = 0 → exclude
":HMX:THD:DC <value>"	<value> = 1 → include Select the THD reference: <value> = 0 → fundamental <value> = 1 → rms
":INP:FILT:LPAS <value>"	Sets the low pass frequency filter state: <value> = 0 -> Low Pass Filter Disabled
":INP:FILT:LPAS?"	<value> = 1 -> Low Pass Filter Enabled Returns the state of the low pass filter.
":INT:START <value>"	Selects either Manual Start Method or Clock Start Method. <value> = 0 → Manual Start Method <value> = 1 → Clock Start Method
":INT:MAN:RUN"	Starts integration when in Manual Start Method. Requires integration mode active, manual start selected and integration not running.
":INT:MAN:STOP"	Stops integration when in Manual Start Method. Requires integration mode active, manual start selected and integration running.
":INT:RESET"	Resets integration values. Requires integration mode active and integration not running.
":INT:CLK:TIME xx-xx-xxX"	Sets the start time for the integrator when configured for Clock Start Method. Start

	time sent in current PM1000+ time format. xx-xx-xxX stands for hh-mm-ss (uppercase 'X' is not used) for 24hr time format or hh-mm-ss(A or P) for AM/PM time format.
":INT:CLK:DATE xxxxxxxx"	Sets the start date for the integrator when configured for Clock Start Method. Start date sent in current PM1000+ date format; xxxxxxx means dd-mm-yyyy or mm-dd- yyyy or yyyy-mm-dd according to the Date Format settings in the Main Menu -> System Configuration -> Clock -> Date Format.
":INT:CLK:DUR <value>"	Sets the duration of the integrator, in minutes, when configured for Clock Start Method. ($1.0 \leq \text{<value>} \leq 1,000,000$)
":GRA:INT:WFM <value>"	Configure integrator graph to display a waveform. <value> = 0 → Whrs <value> = 1 → Ahrs <value> = 2 → Vahrs <value> = 3 → VArhrs <value> = 4 → Watts <value> = 5 → VA <value> = 6 → Var <value> = 7 → Amps <value> = 8 → Volts
":GRA:INT:SHW"	Change display to show integrator graph. Return to results screen with the :DSP:Z04 command.
":GRA:INT:SCL <value>"	Configure vertical scale for the selected result in the integrator graph. ($0.0999 \leq$ <value> $\leq 100,000$)
":GRA:INT:DUR <value>"	Configure the horizontal scale (duration), in minutes, when configured for Manual Start Method. ($1.0 \leq \text{<value>} \leq 1,000,000$)
":MOD:NOR"	Sets normal mode.
":MOD:INR"	Sets inrush mode.
":MOD:INT"	Sets integrator mode.

":MOD:SBY"	Sets standby power mode.
":MOD:BAL"	Sets ballast mode.
":MOD?"	Returns the current mode. 0 = Normal 1 = Ballast 2 = Inrush 3 = Standby 4 = Integrator
":MOD:INR:RNG <value>"	Set Inrush current range <value> = 1 through 6.
":MOD:INR:VRNG <value>"	Set Inrush voltage range <value> = 1 through 4.
":MOD:INR:CLR"	Clears the Apk value when in Inrush mode.
":MOD:SBY:PER <value>"	Sets the user defined period of averaging in Low Power Standby mode. <value>= 1 to 300 seconds.
":DSP:Z04"	Displays 4 results screen.
":DSP:Z14"	Displays 14 results screen.
":REM:OFF"	Returns PM1000+ from remote control.
":RNG:VLT:FIX <value>"	Fixes voltage range <value> = 1 (10V) to 4 (1000V)
":RNG:AMP:FIX <value>"	Fixes current range <value> = 1 (0.1A) to 6 (100A)
":RNG:VLT:AUT"	Sets voltage on auto range.
":RNG:AMP:AUT"	Sets current on auto range.
":RNG:VLT?"	Returns the current voltage range.
":RNG:AMP?"	Returns the current amps range.
":RNG:VLT:AUT?"	Returns : 0 → Range fixed. 1 → AutoRange engaged.
":RNG:AMP:AUT?"	Returns : 0 → Range fixed. 1 → AutoRange engaged.
"*RST"	Resets the PM1000+ to default settings.
":SCL:VLT <value>"	Sets voltage scaling <value> = scaling factor 0.0001 to 100000.
":SCL:AMP <value>"	Sets current scaling <value> = scaling factor 0.0001 to 100000.
":SCL:VLT?"	Returns the current voltage scaling factor.

":SCL:AMP?"	Returns the current amps scaling factor.
":SEL:CLR"	Clears the results selection list.
":SEL:WAT"	Selects watts.
":SEL:VAS"	Selects VA.
":SEL:VAR"	Selects Var.
":SEL:VLT"	Selects Vrms.
":SEL:AMP"	Selects Arms.
":SEL:PWF"	Selects PF.
":SEL:VPK+"	Selects Vpk+ (most positive peak).
":SEL:VPK-"	Selects Vpk- (most negative peak).
":SEL:APK+"	Selects Apk (most positive peak).
":SEL:APK-"	Selects Apk (most negative peak).
":SCL:VCF"	Selects Vcf.
":SCL:ACF"	Selects Acf.
":SEL:WHR"	Selects watt hrs.
":SEL:VAH"	Selects VA hrs.
":SEL:VRH"	Selects VAr hrs.
":SEL:AHR"	Selects A hrs.
":SEL:VDF"	Selects Vdf.
":SEL:ADF"	Selects Adf.
":SEL:FRQ"	Selects frequency.
":SEL:RES"	Selects resistance R.
":SEL:IMP"	Selects impedance Z.
":SEL:REA"	Selects reactance X.
":SEL:VHM"	Selects voltage harmonic series.
":SEL:AHM"	Selects current harmonic series.
":SEL:HRS"	Selects integration elapsed time.
":SEL:VDC"	Selects Volts DC.
":SEL:ADC"	Selects Amps DC.
":SEL:VRNG"	Add the active voltage range to the screen.
":SEL:ARNG"	Add the active current range to the screen.
":SHU:INT"	Selects internal shunt.
":SHU:EXT"	Selects external shunt.
":SHU?"	Returns the current shunt setting 0 = internal 1 = external.
":SYST:TIME?"	Returns the current time setting.
":SYST:DATE?"	Returns the current date setting.
":SYST:SET:TIME <value>"	Sets the RTC time <value> = Example 10-10-00.

":SYST:SET:DATE <value>"	Sets the RTC date <value> = Example 12-12-2006.
":SYST:FOR:TIME <value>"	Sets the time format <value> where 0 = 12 Hour and 1 = 24 Hour.
":SYST:FOR:DATE <value>"	Sets the RTC date format <value> = 0 mmddyyyy; 1 = ddmmyyyy; 2 = yyyyymmdd
":SYST:ZERO <value>"	Set auto zero: <value> = 0 → disabled <value> = 1 → enabled
":SYST:ZERO?"	Read auto zero state.

5.3. SENDING AND RECEIVING COMMANDS.

As states before, there are many ways in which to send commands to the PM1000+, but there are some common rules for all methods.

- All instructions should be terminated with a line feed (ASCII 10) character
- All returned information will be terminated by a line feed (ASCII 10) character
- Only one instruction can be sent at a time. ":SEL:VLT;:SEL:AMP" is not a valid command.
- For all commands that configure the unit, allow 0.5 seconds between each command or use flow control to wait until the next command is sent.
- Results are updated approximately every 0.5 seconds.
- A range change will result in the results not being updated for the 0.5 second interval. Also, the running of auto-zero, which happens every 1 minute, will result in no new results for approximately 1 second. To avoid both of these scenarios, ranges can be fixed, and auto-zero can be disabled.

Note: When utilizing communications via the Ethernet interface on the PM1000+, all communications will be responded to with a carriage return character, i.e. ASCII CR (0x0D). In the examples below the carriage return character is represented by "[CR]".

Example 1: User queries the PM1000+ to determine the status of the blanking setting and the PM1000+ responds with a CR added to the end of the string;

```
USER:      "BLK?"
```

PM1000+: "1[CR]"

The PM1000+ responds as normal with a CR character added to the end of the string.

Example 2: User sends a command to the PM1000+ to disable blanking and the PM1000+ responds with a CR character;

USER: "BLK:DIS"

PM1000+: "[CR]"

The PM1000+ responds with a CR character.

Utilizing all other communication methods the PM1000+ does not reply with a CR to every communication.

5.4. COMMUNICATIONS EXAMPLES.

Basic selection and returning of result.

The results are returned using the FRD command. This returns the results that are shown on the screen, in the order in which they appear on the screen. As results are selected using comms, the results are added to the bottom of the list, with the exception of harmonics, which always appear at the end of the list.

:SEL:CLR clears all results

:SEL:VLT

:SEL:AMP

:SEL:FRQ

:SEL:WAT

:SEL:VAS

:SEL:VAR

:SEL:PWF

:SEL:VPK+

:SEL:APK+

:FRD? Returns Vrms, Arms, Frequency, Watts, VA, Var, power factor, Vpeak + and Vpeak- in floating point format.

:FRF? Returns the results selected for confirmation using the label that appears on the display. In this case will return, "Vrms, Arms, Freq, Watt, VA, Var, PF, Vpk+, Apk+

Returning Results Repeatedly

The PM1000+ updates the results every 500ms. To return results as soon as they are available, set up the DSE register to enable bit 1, the New Data Available (NDV) bit. Then read the DSR register using the ":DSR?" command until it tells indicates that there is new data available, and then then send a ":FRD?" command to get selected results.

```
":DSE 2" // This enables the NDV bit.
```

```
While strDSR <> "2"
```

```
    ":DSR?"
```

```
    strDSR = received data
```

```
WEND
```

```
":FRD?"
```

```
Receive results
```

Harmonics

To return harmonics, first the number of harmonic and the scope need to be selected and then they need to be added to the list of results on the display.

```
:HMX:VLT:SEQ 0 Select odd and even harmonics (use 1 to select odd harmonics only)
```

```
:HMX:VLT:RNG 9 Return all harmonic from 1 to 9.
```

```
:SEL:VHM Add Voltage harmonics to the list.
```

Now, assuming :SEL:CLR has not been issued after example 1, then the following results would be returned by :FRD?

Vrms, Arms, Freq, Watt, VA, Var, PF, Vpk+, Apk+, Vh1 Mag, Vh1 phase, Vh2 Mag, Vh2 phase, Vh9 Mag, Vh9 phase.

Standby power

First, select standby power mode

:MOD:SBY:PER 60	Set the standby power mode period to 60 seconds.
:MOD:SBY	
:SEL:CLR	Clears selection of results
:SEL:VLT	Selects Vrms
:SEL:WAT	Selects Watts
:SEL:FRQ	Selects Frequency
:SEL:VCF	Selects Volts crest factor
:SEL:VDF	Selects Volts distortion factor
:RNG:VLT:FIX 4	Fix the voltage range to 1000Vpk
:RNG:AMP:FIX 3	Fix the current range to 1.6Apk

Wait 60 seconds

:FRD?	Read back values including average power over 60 seconds
-------	--

Wait 60 seconds

:FRD?	Read back value including average power over 60 seconds. Check against previous power.
-------	---

Inrush

:MOD:INR	Select in rush mode
----------	---------------------

:MOD:INR:RNG 4 Fixes the current range for in rush mode to range 4 (6.25Apk)

:MOD:INR:VRNG 4 Fixes the voltage range for in rush mode to range 4 (900Vpk)

:MOD:INR:CLR

:SEL:CLR Clear measurements

:SEL:APK+ Selects peak positive current

:SEL:APK- Selects peak negative current

Ensure equipment under test is off

:MOD:INR:CLR Clear the Apk+ and Apk-

Switch on equipment under test

:FRD? Returns Apk+ and Apk-.

5.5. STATUS REPORTING

Status Byte

The PM1000+ uses a similar status byte to IEEE488.2. The PM1000+ Status Byte Register (STB) contains the ESB and DAS bits. These two bits indicate a non-zero state in the Standard Event Status Register (ESR) or the Display Data Status Register (DSR) respectively.

The ESR and DSR each have enable registers, ESE and DSE respectively, that are set by the user. These enable registers act as a mask to reflect chosen elements of the appropriate status registers to the Status Byte Register. Setting the appropriate bit of the enable register to 1 configures transparency.

If any of the status registers are read, that register is reset to zero.

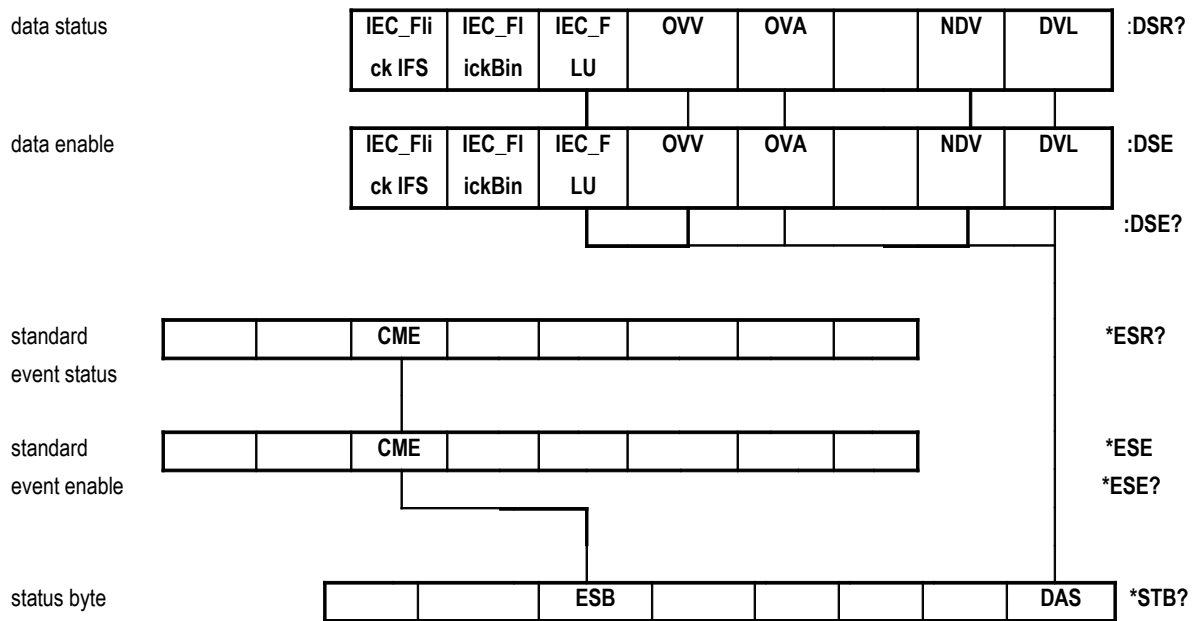

Status Byte Register (STB)

Read by “*STB?”.

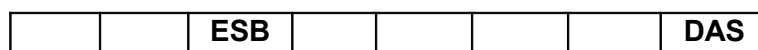

Bit 5 - ESB Summary bit to show standard event status.

Bit 0 - DAS Summary bit to show display data available.

Display Data Status Register (DSR)

Read by “:DSR?” or in summary by *STB? DAS bit. On power-up DSR is initialized to zero. When read using the “:DSR?” command the register is cleared.

IEC_Flick IFS	IEC_Flick Bin	IEC_FLU	OVV	OVA		NDV	DVL
--------------------------------	--------------------------------	----------------	------------	------------	--	------------	------------

Bit 7 – IEC_FlickIFS Set to indicate availability of new IFS data in IEC Flicker mode. Cleared when read.

Bit 6 – IEC_FlickBin Set to indicate availability of new IEC Flicker Bin data in IEC Flicker mode. Cleared when read.

Bit 5 – IEC_FLU Set to indicate availability of new IEC Fluctuating Harmonics data in IEC Fluctuating Harmonics mode. Cleared when read.

Bit 4 - OVV Set to indicate there is a voltage range overload. Automatically cleared when range overload clears.

Bit 3 - OVA Set to indicate there is a current range overload. Automatically cleared when range overload clears.

Bit 1 - NDV Set to indicate that new data has become available since the last :DSR? command. Cleared when read.

Bit 0 - DVL Set to indicate the availability of data. Cleared when read.

Display Data Status Enable Register (DSE)

Read by “:DSE?” and set by “:DSE <value>”.

IEC_Flick IFS	IEC_Flick Bin	IEC_FLU	OVV	OVA		NDV	DVL
--------------------------------	--------------------------------	----------------	------------	------------	--	------------	------------

Bit 7 – IEC_FlickIFS Enable IEC_FlickIFS bit in DSR. (Default to enabled on power-up.)

Bit 6 – IEC_FlickBin Enable IEC_FlickBin bit in DSR. (Default to enabled on power-up.)

Bit 5 - IEC Enable IEC bit in DSR. (Default to enabled on power-up.)

Bit 4 - OVW Enable OVW bit in DSR.

Bit 3 - OVA Enable OVA bit in DSR.

Bit 1 - NDV Enable NDV bit in DSR. (Default to enabled on power-up.)

Bit 0 - DVL Enable DVL bit in DSR. (Default to enabled on power-up.)

Standard Event Status Register (ESR)

Read by “*ESR?” or in summary by the ESB bit in STB.

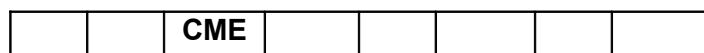

Bit 5 - CME Command error; command not recognized.

Standard Event Status Enable Register (ESE)

Read by “*ESE?” and set by “*ESE <value>”. Cleared when read.

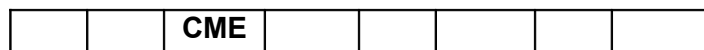

Bit 5 - CME Enable CME bit in ESR. (Default to enabled on power-up.)

6. SOFTWARE

There are a number of useful software utilities available for the PM1000+. The aim of these utilities is to enable users to gather information easily from the PM1000+ and record this information on a PC.

6.1. IEC 61000-3-2/3 PRE-COMPLIANCE SOFTWARE

Aim

The aim of the IEC 61000-3 software for the PM1000+ is to provide pre-compliance measurement information for the IEC 61000-3-2 current harmonics standard and the IEC61000-3-3 voltage flicker standard.

The software is provided at no cost and can be installed on as many PCs as you wish. However, the software will only work with a PM1000+ that has had the IEC option enabled (see section 4.9). To help you decide whether the feature is what you require, each PM1000+ will allow 10 current harmonic or flicker tests to be run before purchase is required. Please contact your Voltech agent to purchase the feature.

Where to find it

The software can be found on Voltech's web site at www.voltech.com in the software and firmware section.

Software Installation

Double click on the file "PM1000IEC6000.exe" and follow the on screen instructions. During the installation you will be prompted to install the National Instruments NI-VISA runtime. Please install this. If a later version exists on your PC, then these files will not be over-written.

Also, you will be prompted to install a Microsoft Access 2000 run time engine. Please install if necessary.

Hardware Setup

In order to make the voltage and current measurements required, the voltage across the unit under test (UUT) and the current flowing in to the UUT need to be measured. While making voltage measurements are relatively straight forward, to measure the current, the conductor has to be “broken” so the current flowing through it can be measured.

For the measurement of voltage and current in normal appliances that plug in to the wall output, Voltech has a Universal Breakout Box.

A connection diagram for the PM1000+ and the breakout box is shown below:

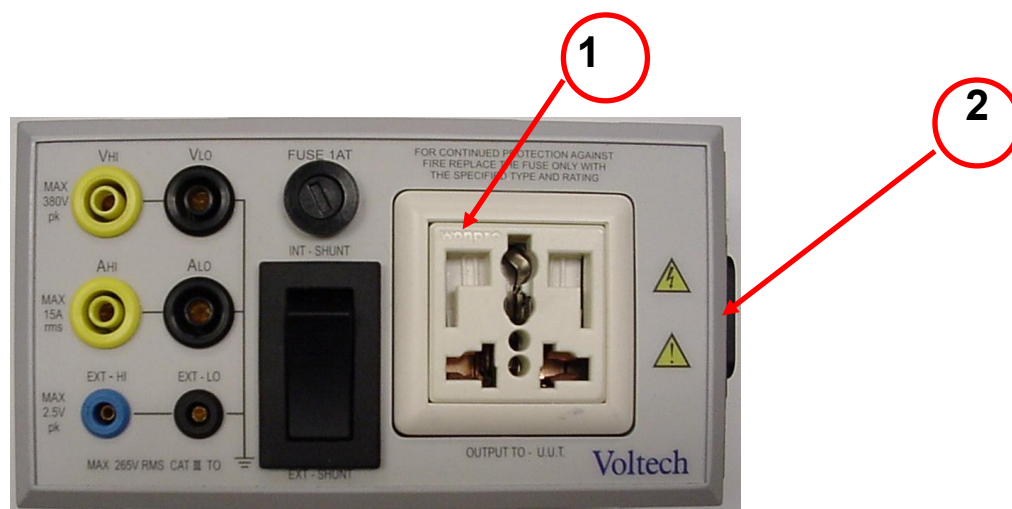

Universal Breakout Box

The UUT is connected to the “OUTPUT TO – U.U.T.” socket, and Universal Breakout Box is connected to the AC source (2). The UUT can be any electrical product that would normally plug in to the wall outlet.

Next the measurement connections need to be made between the breakout box and the PM1000+. These connections are shown below:

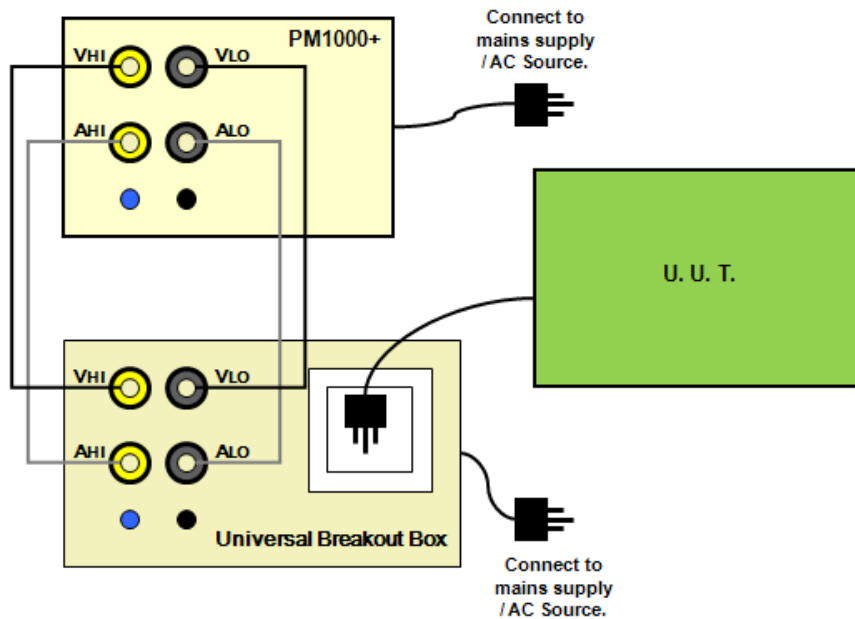

Universal Breakout Box Connection Diagram

Finally, in order for the PM1000+ to send results to the PC, a data connection needs to be made. The IEC software supports either USB or GPIB (not available on the basic comms version of the PM1000+).

Running the Fluctuating Harmonics Test

Starting the Software

To start the PM1000+ IEC61000-3 software, click on the PM1000IEC61000 icon, on the included PC's desktop, as shown below.



PM1000+ IEC Software Icon

Confirm Communication set-up

After the software starts up, you should see a message in the bottom left of the main window that states that a PM1000+ has been detected. An example for USB connection is shown below:

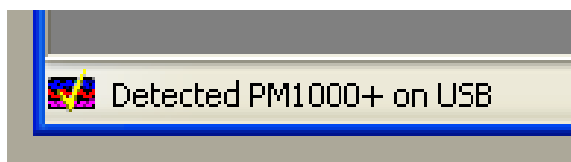

Detected PM1000+ on USB

Configure the Fluctuating Harmonics Test

Next from the top-level menu, open Product → Configure for Harmonics. You will now see the configuration window for the Fluctuating Harmonics Test. This can be seen below:

Configure for Test

Source

Enter your source voltage and frequency in this box. Note that the IEC 61000-3 standard has not set limits for systems with nominal voltages less than 220 V (line-to-neutral). The software will give a warning for settings that will cause non-compliance with the IEC 61000-3-2 standard.

If you are running the test on a system with a nominal voltage less than 220 V, the software will run and give results, however it will flag the results as non-compliant.

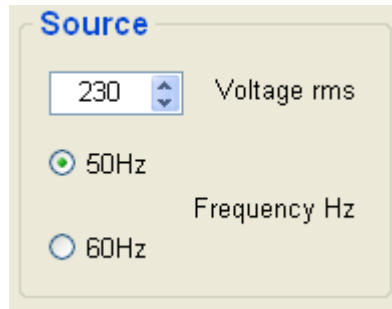

The screenshot shows a dialog box titled "Source" with a light beige background. At the top, the title "Source" is in blue. Below the title, there is a dropdown menu showing "230" with a blue arrow icon, followed by the text "Voltage rms". Underneath, there are two radio button options for frequency: "50Hz" (which is selected, indicated by a green dot) and "60Hz". To the right of these options is the text "Frequency Hz".

Source

Current Range

Enter the current range appropriately.

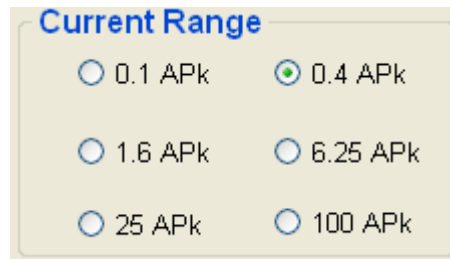

The screenshot shows a dialog box titled "Current Range" with a light beige background. The title "Current Range" is in blue. Below the title, there are six radio button options arranged in two columns. The first column contains "0.1 APk", "1.6 APk", and "25 APk". The second column contains "0.4 APk" (which is selected, indicated by a green dot), "6.25 APk", and "100 APk".

Current Range Selection

Part Name and Test Description Input

This section allows the user to enter information about the test that will be run. For the purposes of this test it can be filled out as seen below:

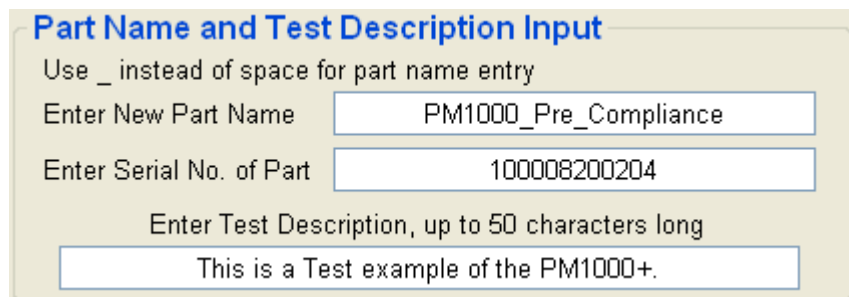

The screenshot shows a dialog box titled "Part Name and Test Description Input" with a light beige background. The title is in blue. Below the title, there is a line of text: "Use _ instead of space for part name entry". There are three input fields: "Enter New Part Name" containing "PM1000_Pre_Compliance", "Enter Serial No. of Part" containing "100008200204", and "Enter Test Description, up to 50 characters long" containing "This is a Test example of the PM1000+."

Part Name and Test Description Input

Class

This section determines the class of the UUT. Please refer to Voltech Application Note 104 for information on determining the class of the UUT.

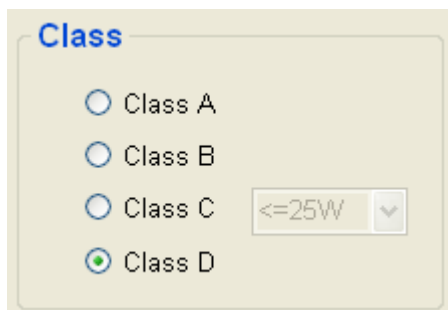

The screenshot shows a dialog box titled "Class" with a light beige background. It contains four radio button options: "Class A", "Class B", "Class C", and "Class D". The "Class D" option is selected, indicated by a green dot. To the right of the "Class C" option is a dropdown menu showing "<=25W".

Class Selection

Normal or Inter-harmonics

Select normal if you would like to test without inter-harmonics or select Inter-harmonics to test with inter-harmonics. We will leave inter-harmonics selected for this test.

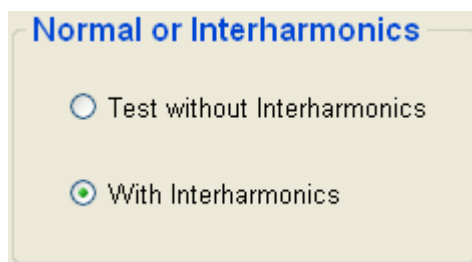

The screenshot shows a dialog box titled "Normal or Interharmonics" with a light beige background. It contains two radio button options: "Test without Interharmonics" and "With Interharmonics". The "With Interharmonics" option is selected, indicated by a green dot.

Select Normal or Inter-harmonics

Test Parameters

Test parameters must also be entered. Depending on the class selected, different parameters are enabled. The on-line help details when each parameter is required and what is meant by the parameter. The on-line help can be accessed by pressing F1.

Test Parameters

Minimum Power Watts

Specified Power Watts

H1 Current Amps

Power Factor

Class Multiplier

Test Duration: Hrs Mins Secs  **00:02:30**
Hrs:Min:Sec

Test Parameters

Also enter the duration of the test. We will leave the default time of 2 minutes and 30 seconds.

Finish Test Configuration

When all of the configuration values have been entered, click on the “Apply and Close Form” button to apply settings.

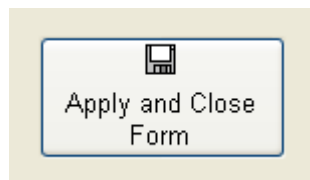

Apply and Close Form Button

Start the Fluctuating Harmonics Test

From the top-level menu, select Run Test → Run Fluctuating Harmonic Test. You will see a window pop up with a “Start Harm/Source Test” button; click on that button.

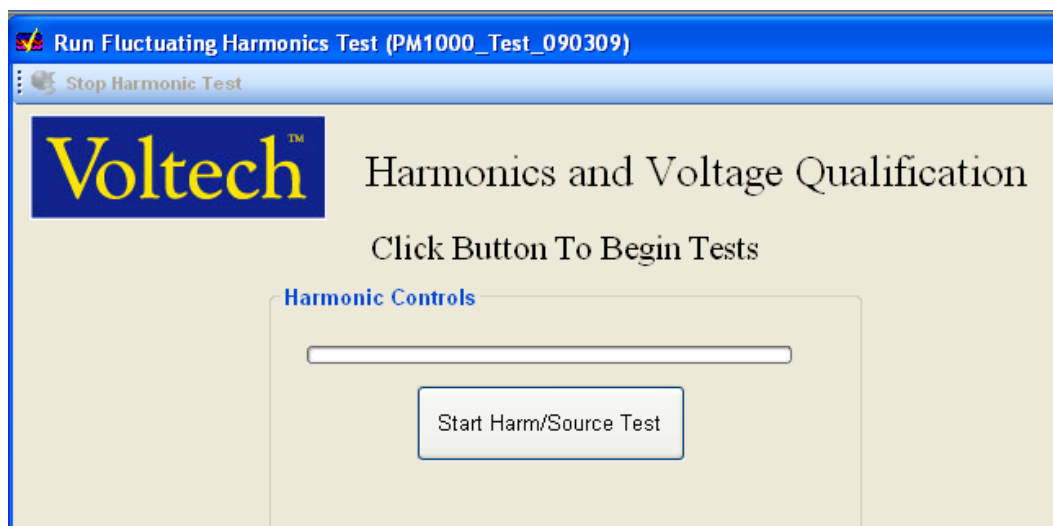

Start Harm/Source Test Button

Next click OK to start the ten second count.

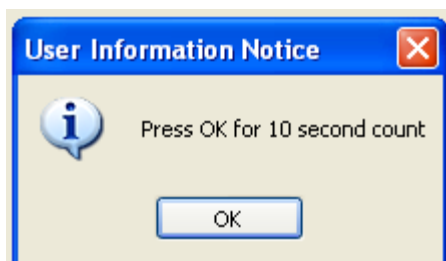

Press OK for 10 second Count

The test should start after the ten second wait required by the standard. While the test runs you will see a display of the current harmonic levels and a countdown timer of the test duration as shown below:

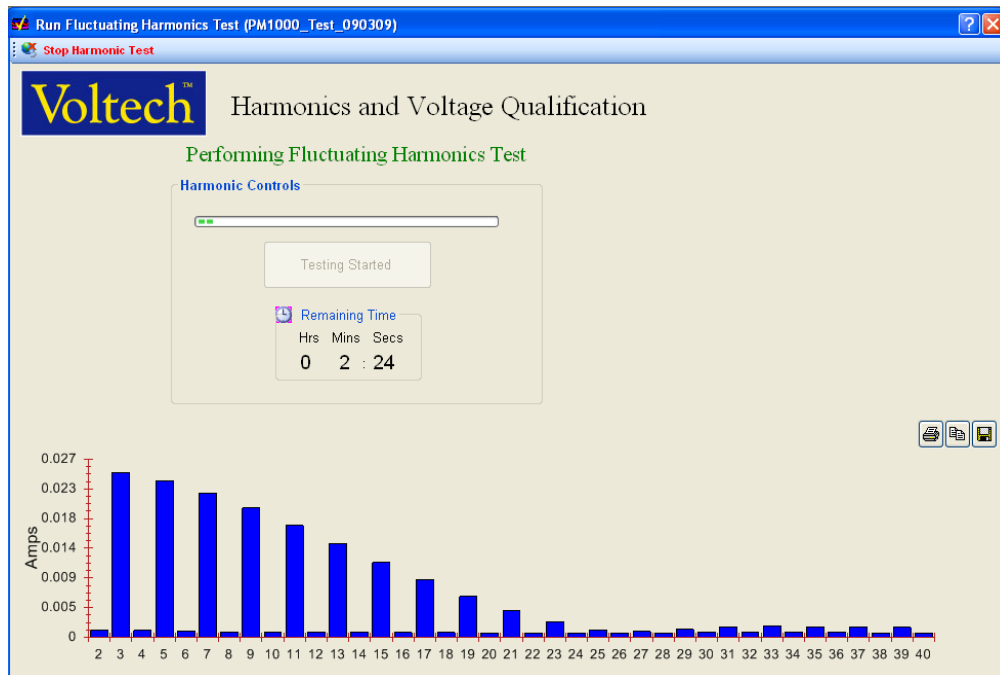

Test Running

Reporting Results

By default the software will display the Main Table Report and the Test Parameters Report. To view other results, click on Results → Open Harmonic Files from the top-level menu. This will open up a window that allows you to select the results you would like to see.

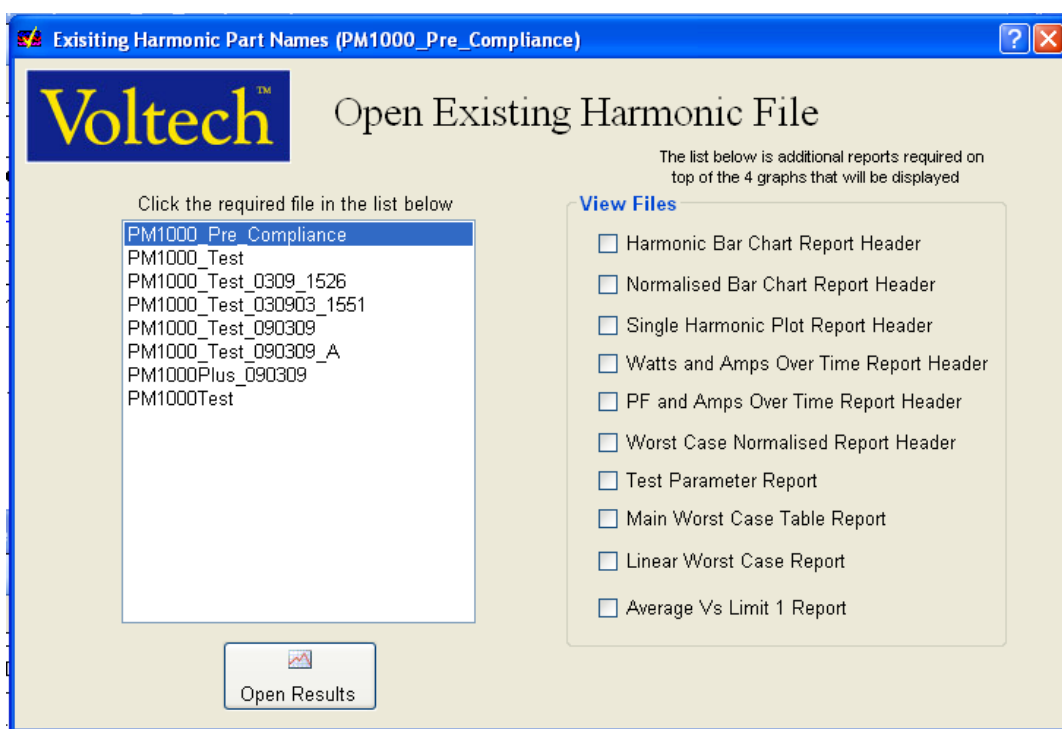

Open Harmonic Results

On the left, select the set of results desired. Then on the right, select the reports that you desire to view.

Running the Flicker Test

To run a flicker test, the initial opening of the software and confirming communications is the same as for running a current harmonics test.

Configure the Flicker Test

From the top-level menu, open Product → Configure for Flicker. You will now see the configuration window for the Flicker Test. This can be seen below:

Voltech Configure Parameters For Flicker Test

Source

230 Voltage rms

50Hz Frequency Hz

60Hz

Part Name and Test Description Input

Use underscore _ instead of space for part name entry

Enter New Part Name PartName

Enter Serial No. of Part SerialNumber

Enter Test Description, up to 50 characters long

This is a Test example

Current Range

0.1 APk 0.4 APk

1.6 APk 6.25 APk

25 APk 100 APk

Complex Impedance

User Input in Ohms for real and imaginary values

Real Imaginary

0.40 0.25

Apply and Close Form

Configure for Test

The majority of the setup is the same as for the current harmonics test. The only difference is the complex impedance.

This area allows you to specify the complex impedance in ohms of the line being tested. Program defaults to 0.4 ohms real and 0.25 ohms imaginary as per IEC standard 61000-3-3.

Complex Impedance

User Input in Ohms for real and imaginary values

Real Imaginary

0.40 0.25

Complex Impedance Input

Finish Test Configuration

When all of the configuration values have been entered, click on the “Apply and Close Form” button to apply settings.

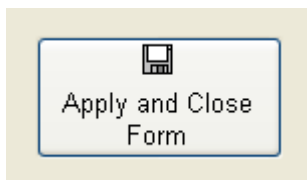

Apply and Close Form Button

Start the Flicker Test

From the top-level menu, select Run Test → Run Flicker Test. You will see a window pop up informing you to have the UUT powered and to allow a warm-up period of at least 30 minutes. Click “OK.”

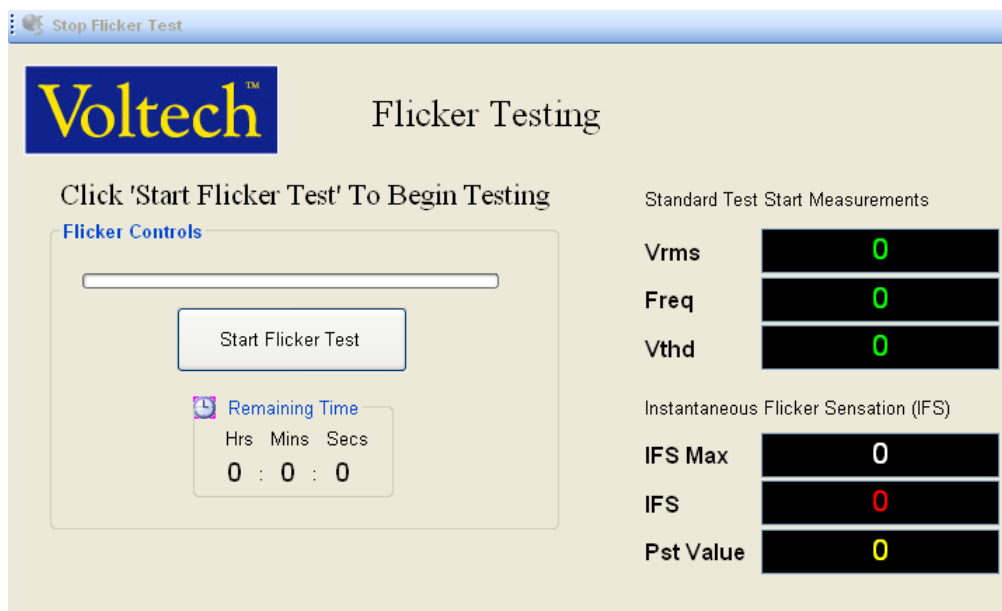

Flicker Test Window

Next click “Start Flicker Test” to start the test. The program will wait thirty seconds to allow measurements to settle and then start the ten minute measurement routine.

While the program runs, the values for maximum IFS and current IFS will continuously update. After the program finishes running, the PST value will be calculated and displayed.

Reporting Results

By default the software will display the Main Table Report and the Test Parameters Report. To view other results, click on Results → Open Harmonic Files from the top-level menu to view harmonics files or Results → Open Flicker Files. This will open up a window that allows you to select the results you would like to see.

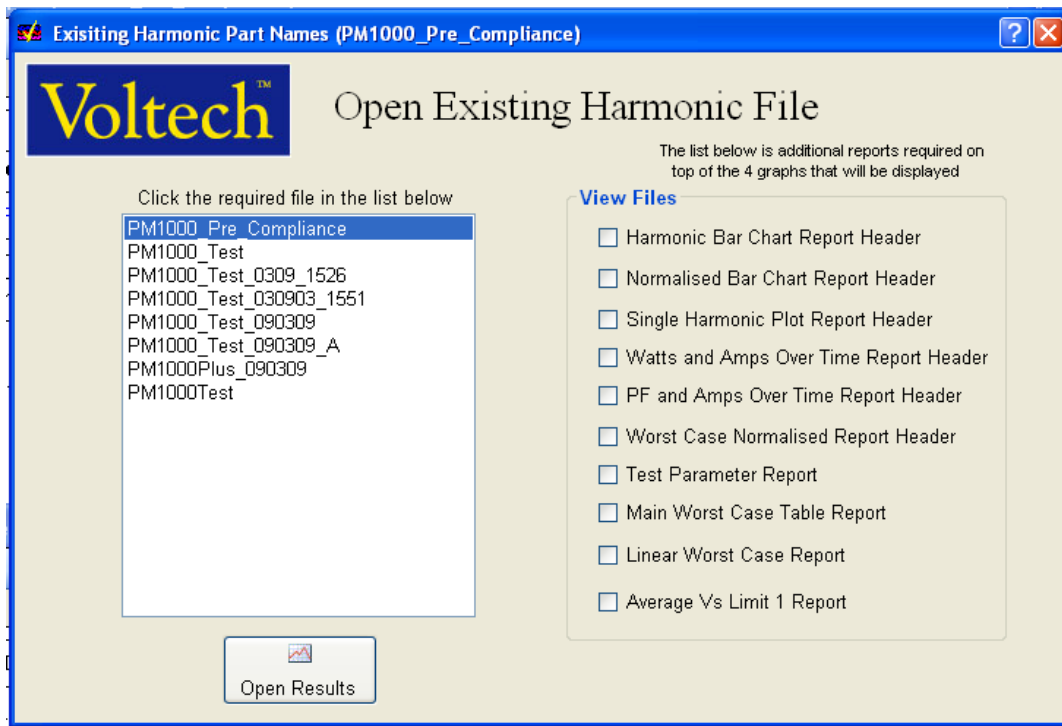

Open Harmonic Results

On the left, select the set of results desired. Then on the right, select the reports that you desire to view.



Open flicker result

To open a flicker result, select the test you would like from the list and click “Open Results.”

Further Information

Also, for information in IEC 61000-3 testing in general, visit the Harmonics and Flicker section of Voltech’s Solutions at www.voltech.com.

6.2. IEC 62301 Low Power Standby Software

Aim

The aim of this software is to enable the user to easily use the PM1000+ to verify their product against the low power standby standard IEC 62031.

Where to find it

The software can be found on Voltech's web site at www.voltech.com in the software and firmware section.

Installation

Double click on the file "IEC62301SoftwareSetup.exe" and follow the on screen instructions. During the installation you will be prompted to install the National Instruments NI-VISA runtime. Please install this. If a later version exists on your PC, then these files will not be over-written.

Further Information

To run the software click on Start -> Program Files -> Voltech Software -> IEC 62301 Software or click on the "IEC 62301 Software" icon on the desktop. When the software runs, you will be asked whether you want to run a setup wizard. If you click no, then you can get to the main application where you can open the help (F1) that contains details on all the features of the software.

6.3. PM1000+ General Purpose Measurement Software

Aim

The aim of this software is to provide general data gathering of results from a PM1000+ to a PC using GPIB, RS232 or USB as a connection method.

The software allows you to view result as values or graphically.

Where to find it

The software can be found on Voltech's web site at www.voltech.com in the software and firmware section.

Installation

Double click on the file “PM1000+SoftwareSetup V3.2.exe” and follow the on-screen instructions. During the installation you will be prompted to install the National Instruments NI-VISA runtime. Please install this. If a later version exists on your PC, then these files will not be over-written.

Further Information

To run the software click on Start -> Program Files -> Voltech Software -> PM1000+ Software or click on the “PM1000+ Software” icon on the desktop.

When the software runs for the first time, you will be asked to choose a language. Please select an appropriate language. Following that you will be asked whether you want to run a quick start. The quick start will walk you through setting up the PM1000+. If you click no, then you can get to the main application where you can open the help (F1) that contains details on all the features of the software.

7. SPECIFICATION

7.1. MECHANICAL

Height 102mm including feet.

Width 223mm without Handle

Width 260mm with Handle

Depth 285mm without Handle

Depth 358mm with Handle Straight out

Weight = 3.2Kg with handle

Accessories

Voltech supplies the PM1000+ Rack Mount Shelf Fixing kit (VPN: 130-024) to mount the PM1000+ in a 19" wide cabinet. A suitable shelf is recommended.

Call your Voltech representative for more information.

7.2. POWER SUPPLY

AC input voltage = 85 - 264V, 45 to 65Hz

Protection = 1AT, 20mm fuse

Consumption = 25VA max.

7.3. COMMUNICATIONS

RS232

9-pin d-type female.

Requires 'straight through' (modem) cable for a pc connection.

1 - open

2 - Tx (o/p)

3 - Rx (i/p)

4 -open

- 5 - 0V
- 6 - Open
- 7 - CTS (i/p)
- 8 - RTS (o/p)
- 9 - Open

AUX/TRIG

For Voltech Use Only.

GPIB

To IEEE488 standard.

USB Peripheral (USB Test and Measurement Class [USBTMC])

USB 2.0 compatible. Will work with any USB 2.0 system.

Full Speed (12Mbits/sec).

- 1 - VBus (i/p)
- 2 - D- (i/p and o/p)
- 3 - D+ (i/p and o/p)
- 4 - 0V (i/p)

For basic communication needs via USB peripheral, the user can try the Agilent Connection Expert contained in the [Agilent IO Libraries Suite 15.0](#).

7.4. MEASURED PARAMETERS

Abbreviation	Description	Units	Formula
V_{RMS}	RMS Voltage	Volt (V)	$V_{RMS} = \sqrt{\frac{1}{T} \int_0^T v_i^2 dt}$
A_{RMS}	RMS Current	Amp (A)	$A_{RMS} = \sqrt{\frac{1}{T} \int_0^T i_i^2 dt}$
F	Frequency	Hertz (Hz)	
W	True Power	Watt (W)	$W = \frac{1}{T} \int_0^T v_i i_i dt$
PF	Power factor		$PF = \left[\frac{Watt}{V_{rms} \times A_{rms}} \right]$
VA	Apparent Power	Volt-Amps (VA)	$VA = [V_{rms} \times A_{rms}]$
VAr	Reactive Power	Volt-Amps Reactive (VAr)	$VAr = \sqrt{(VA)^2 - W^2}$
V_{CF}	Voltage Crest Factor		$CF = \frac{Peak Value}{RMS Value}$
A_{CF}	Current Crest Factor		$CF = \frac{Peak Value}{RMS Value}$
V_{THD}	Voltage Total Harmonic Distortion	%	$series = \frac{\sqrt{(H0^2) + H2^2 + H3^2 + H4^2 + H5^2 + \dots}}{REF}$ <p>or</p> $difference = \frac{\sqrt{V_{rms}^2 - H1^2}}{REF}$
A_{THD}	Current Total Harmonic Distortion	%	$series = \frac{\sqrt{(H0^2) + H2^2 + H3^2 + H4^2 + H5^2 + \dots}}{REF}$ <p>or</p>

			$\text{difference} = \frac{\sqrt{Arms^2 - H1^2}}{REF}$
Z	Impedance	Ohm (θ)	$Z = \frac{V_{rms}}{I_{rms}}$
V _{DC}	DC Voltage	Volt (V)	$V_{DC} = \frac{1}{T} \int_0^T v dt$
A _{DC}	DC Current	Amp (A)	$A_{DC} = \frac{1}{T} \int_0^T i dt$
R	Resistance	Ohms (Ω)	$R = \frac{Vf}{Af} \times \cos \theta \quad (\theta = \text{phase angle})$
X	Reactance	Ohms (Ω)	$X = \frac{Vf}{Af} \times \sin \theta \quad (\theta = \text{phase angle})$
V _{h_n}	Voltage harmonic n	Volt (V)	$\text{Mag} = \sqrt{(Vh_n \cdot r^2 + Vh_n \cdot q^2)}$ $\text{Phase} = \tan^{-1} \left(\frac{Vh_n \cdot q}{Vh_n \cdot r} \right)$
A _{h_n}	Current harmonic n	Amp (A)	$\text{Mag} = \sqrt{(Ah_n \cdot r^2 + Ah_n \cdot q^2)}$ $\text{Phase} = \tan^{-1} \left(\frac{Ah_n \cdot q}{Ah_n \cdot r} \right)$
V _{PK +}	(+)ve Peak Voltage	Volt (V)	$\max\{v\}$
V _{PK -}	(-)ve Peak Voltage	Volt (V)	$\min\{v\}$
A _{PK -}	(+)ve Peak Current	Amp (A)	$\max\{i\}$
A _{PK +}	(-)ve Peak Current	Amp (A)	$\min\{i\}$

7.5. MEASUREMENT ACCURACY

The table below lists the formulae for calculating the accuracy specification for each measurement.

In the equations below:

- It is assumed the waveform measured is a sine wave.
- F is the frequency measured in kHz.
- F_h is the frequency of the harmonic in kHz.
- h_n is the harmonic number.
- V is the voltage measured in V.
- I is the current measured in A.
- Θ is the phase angle in degrees (i.e. phase of the current with reference to the voltage).

All specifications are valid 23°C ±5°C.

Temperature coefficient ±0.02% of reading / °C, 0 to 18°C, 28 to 40°C.

VOLTAGE		
	RANGES	900, 215, 46, 10 Vpk
	Frequency range	10Hz to 1MHz
	Max	600Vrms
	Input Impedance	1 MOhm
	Crest Factor	20
RMS	Accuracy	0.1% of Reading + 0.1% of range + 4mV + (0.02 * F)% of reading
45-65Hz, 95-265Vrms, THD < 5%	Accuracy	0.05% of reading + 0.05% of range ^{Note1}
DC	Accuracy	0.1% of Reading + 0.4% of range + 5mV
	Maximum DC	600Vdc
VOLTAGE +/-PEAK	Accuracy	0.5% of Reading + 0.5% of Range + (0.02 * F)% of reading
Effects of Common Mode Voltage	100Vrms, 100kHz	<500mV
MAX VOLTAGE	Peak continuous	1500Vpk
OVERANGE	Peak < 1 second	5000Vpk
Input Capacitance	Input to Earth	35pF
CURRENT		
	RANGES	100(1.25), 25(0.3125), 6.25(0.0781), 1.6(0.02), 0.4(0.005), 0.1(0.00125) Apk

		(external shunt input Vpk)
	Frequency range	10Hz to 1MHz
	Peak continuous	20Arms
	Peak < 1 second	60Arms
	Input Resistance	12.5 mOhm
	Crest Factor	20 (Peak/RMS)
RMS	Accuracy	0.1% of Reading + 0.1% of range + 1mA + (0.02 * F)% of reading
45-65Hz, Internal Shunt	Accuracy	0.1% of Reading + 0.1% of range ^{Note1}
45-65Hz, Ext. Shunt	Accuracy	0.1% of Reading + 0.1% of range + (20uV/Zext) ^{Note1,2}
DC	Accuracy	0.1% of Reading + 0.4% of range + 1mA
	Max	20Adc
CURRENT +/- PEAK	Accuracy	0.5% of Reading + 0.5% of Range + (0.02 * F)% of reading
Effects of Common Mode Voltage	100Vrms, 100kHz	Less than 10mArms
Input Capacitance	Input to Earth	35pF
WATTS	RANGES	1W to 90kW
	Frequency range	10Hz to 1MHz
RMS	Accuracy	0.2% of Reading + 0.1% of range +4mW + (0.05 / PF * F)% of reading
45-65Hz	Accuracy	[(Verr / Vreading) + (Aerr/Areading)] * Watts Reading] + (0.1/PF)% of Watts reading ^{Note1,3}
DC	Accuracy	0.2% of Reading + 0.4% of range +4mW
VA	RANGES	1 VA to 90kVA
	Frequency range	10Hz to 1MHz
RMS	Accuracy	0.2% Reading + 0.1 % of range +4mVA + (0.05 * F)% of reading
45-65Hz	Accuracy	[(Verr / Vreading) + (Aerr/Areading)] * VA Reading] ^{Note1,3}
DC	Accuracy	0.2% of Reading + 0.4% of range +4mVA
VAr	RANGES	1 VAr to 90kVAr
	Frequency range	10Hz to 1MHz
RMS	Accuracy	0.2% of Reading + 0.1% of range +4mVAr + ((0.05 / (1- PF)) * F)% of reading
45-65Hz	Accuracy	[(Verr / Vreading) + (Aerr/Areading)] * VAr Reading] + (0.1 / (1 - PF))% of VAr reading ^{Note1,3}
DC	Accuracy	0.2% of Reading + 0.4% of range +4mVAr

POWER FACTOR	Range	+/- 0.000 to 1.000
	Accuracy	+-(0.002+-(0.001 / PF) * F)
FREQUENCY	Range	DC and 10Hz to 1MHz (Maximum 22kHz when frequency source is set to current)
	Accuracy	0.1%
VOLTAGE CREST FACTOR	RANGE	1.00 to 20.0
	Accuracy	%Vpk error + %Vrms error
CURRENT CREST FACTOR	RANGE	1.00 to 20.0
	Accuracy	%Apk error + %Arms error
PEAK INRUSH CURRENT	RANGE	100Apk
	Accuracy	2% of range +/- 20mA
HARMONIC ANALYSIS	Number of Voltage & Current harmonics	50
	Max. Harmonic Frequency	450kHz
	Magnitude Accuracy	0.2% of Reading + 0.1% of Range +0.04% per kHz of harmonic
	Phase Accuracy	$0.1^\circ + [(Rng / \text{Harmonic Reading}) * 0.02]^\circ + [F_n * 0.045]^\circ + [h_n * 0.1]^\circ$
	Frequency Range	10Hz to 450kHz
TOTAL HARMONIC DISTORTION	Range & Accuracy	Range 0-999% Accuracy 0.4% + (0.1 * F)%
STANDBY POWER	Time Window	1-600 sec
	Resolution	1 second
IMPEDANCE	Range	0.005Ohms to 1Mohm
	Accuracy	0.2% of Reading + 0.1% of range +5mOhms +(0.05 / PF * F)% of reading
RESISTANCE	Range	0.005Ohms to 1Mohm
	Accuracy	0.2% of Reading + 0.1% of range

		+5mOhms +(0.05 / PF * F)% of reading
REACTANCE	Range	0.005Ohms to 1Mohm
	Accuracy	0.2% of Reading + 0.1% of range +5mOhms +((0.05 / (1- PF)) * F)% of reading
EXTERNAL SHUNT	Input Range	+/- 1250 mVpk
SCALING		0.0001 to 100000
IEC Current Harmonics Mode	Accuracy	Meets Class II Voltage and Current measurements as specified in IEC 61000-4-7:2002 Table 1.
IEC Flicker Pst	Accuracy	+/- 5% for Pst of 0.3 to 5.

Notes:

1. To meet the enhanced specification for 45-65Hz, the firmware version of the product must be 4.22 or greater, and the "Adjustment Type" must be "Full Enhanced". The adjustment type can be viewed in the Unit Configuration menu under System Configuration (see section 4.9).
2. Zext is the external shunt impedance used and must be less than or equal to 10 Ohms.
3. For Watts, VA and VAr, voltage and current readings must also meet the criteria stated for 45-65Hz measurements.
4. All the stated accuracies are based upon a minimum of a 30 minute warm up period.
5. Common mode specification is only valid for hardware revision 11 or greater and firmware version 4.13 or greater.
6. If no frequency is measured, then the signal is considered DC for the purpose of accuracy.
7. Specifications are valid only when applicable voltage and current inputs are > 10% of range. The exception is harmonics where the specification is valid when the magnitude of the harmonic is >2% of range.

Example of Volts, Amps and Watts Accuracy Calculations

Example signals:

120V, 2.5A, 60Hz, and a power factor of 0.8, giving a Watts of 240W

Volts Accuracy

Specification: 0.1% of reading + 0.1% of range, +4mV + (0.02 * F)% of reading

Note: F is the frequency of measurement in kHz

Reading = 120V

Range = 215V

Frequency = 0.06kHz

$$\begin{aligned}\text{Accuracy} &= 0.1\% \text{ of } 120\text{V} + 0.1\% \text{ of } 215\text{V} + 4\text{mV} + (0.02 * 0.06)\% \text{ of } 120\text{V} \\ &= 120\text{mV} + 215\text{mV} + 4\text{mV} + 1.44\text{mV} \\ &= 340.44\text{mV} \text{ or } 0.284\% \text{ of signal.}\end{aligned}$$

Current Accuracy

Specification: 0.1% of reading + 0.1% of range, +1mA + (0.02 * F)% of reading

Note: F is the frequency of measurement in kHz

Reading = 2.5A

Range = 6.25A

Frequency = 0.06kHz

$$\begin{aligned}\text{Accuracy} &= 0.1\% \text{ of } 2.5\text{A} + 0.1\% \text{ of } 6.25\text{A} + 1\text{mA} + (0.02 * 0.06)\% \text{ of } 2.5\text{A} \\ &= 2.5\text{mA} + 6.25\text{mA} + 1\text{mA} + 0.03\text{mA} \\ &= 9.78\text{mA} \text{ or } 0.39\% \text{ of signal.}\end{aligned}$$

Watts Accuracy

Specification: 0.2% of reading + 0.1% of range, +4mW + (0.05/PF * F)% of reading

Note: F is the frequency of measurement in kHz

Reading = 240W

Range = Volts range * Amps range = 215V * 6.25A = 1343.75W

Frequency = 0.06kHz

Power Factor = 0.8

Accuracy = 0.2% of 240W + 0.1% of 1343.75W + 4mW + (0.05 / 0.8 * 0.06)% of 240W
= 480mW + 1343.75mW + 4mW + 9mW
= 1.837W or 0.77% of signal.

8. WARRANTY, SERVICE AND UPDATES

8.1. WARRANTY

The Voltech PM1000+ Power Analyzer is warranted against defects in materials and workmanship for a period of twelve (12) months from the date of shipment.

In the event of failure of a customer unit during this period, Voltech will:

- At Voltech's discretion, repair or replace the faulty unit free-of-charge for a unit returned to an authorized service center. Shipment from the customer address will be the responsibility of the customer.

Voltech reserves the right to waive this benefit in any event where it is clear upon inspection that the cause of the failure is due to customer misuse.

Voltech will be the sole arbiter in this circumstance.

- Pay all return shipment charges from the Voltech service center to the customer.
- Repair/verify the customer unit before dispatch. A certificate of verification will be issued as a matter of course.

The PM1000+ is a complex product and may not be completely free of errors. You are advised to verify your work. In no event will Voltech be liable for direct, indirect, special, incidental or consequential damages arising out of the use of or inability to use the PM1000+ or its accessories, even if advised of the possibility of such damage. In particular, Voltech is not responsible for any lost profits or revenue, loss of use of software, loss of data, cost of substitute products, claims by third parties, or for other similar costs.

8.2. CALIBRATION AND SERVICE

To confirm the accuracy of your PM1000+ a calibration should be carried out every 12 months.

Calibration (adjustment) is carried out using purpose-built equipment. The calibration can be performed by an authorized Voltech service center.

For details of calibration facilities and any other service requests, please see the service area of our website at www.voltech.com. Voltech strongly recommends that you discuss your service requirements with your supplier before service is needed.

8.3. OBTAINING SERVICE AND APPLICATIONS SUPPORT

Please see the service and applications support centers on our website at www.voltech.com.

8.4. UPDATING FIRMWARE

Regular firmware updates will be made available and maintenance updates are free of charge for all users.

Please see the applications support center on our website at www.voltech.com.

8.5. LANGUAGE UPLOAD OPTION

Voltech Instruments now offers a language upload option on PM1000+ units with a hardware version of 52 and higher. This option allows the user to see the menus and help in the loaded language. It also expands the help detail over the standard option.

The hardware version of the PM1000+ can be found in the Unit Configuration Menu under the System Configuration main menu (see section 4.9).

To allow for multiple languages to be support, from version 4.23 onwards there will be two firmware files.

“Flash.vlt” (VPN 11-144) will be compatible with all hardware versions, but will not support language files.

“Flash_language.vlt” (11-155) will be compatible with version 52 and greater PM1000+s and support non-English language files.

If you only desire the text of your PM1000+ to be in English, then there is no need to load the “Flash_language.vlt” file and an associated language file.

Check the Voltech website at www.voltech.com to see what languages are available and find instructions on how to download languages.

NOTE: If you upload the firmware that supports language files (“flash_language.vlt”) in to a revision 52 unit or higher, but you have not yet loaded a language file, the PM1000+ will display a red screen. To rectify this problem, either load a language file or load the “flash.vlt”, non-language support version of the firmware.

If you upload the firmware that supports language files (“flash_language.vlt”) in to a revision 51 unit or lower, the PM1000+ will display a blue screen. To rectify this problem, load the “flash.vlt”, non-language support version of the firmware.

9. SAFETY INFORMATION

9.1. SAFETY FEATURES

The PM1000+ has been designed with safety features, such as shrouded safety connectors, that provide the operator with a high level of protection against the risk of electric shock. As with any dangerous equipment, however, it is important that an assessment of the overall risk to safety is made during installation. It is the user's responsibility to ensure compliance with any local regulations that may be applicable to the health and safety of operators.

If the PM1000+ is used in a manner not specified by Voltech Instruments, Inc., the protection provided by the equipment may be impaired.

9.2. SAFETY INSTRUCTIONS



- The PM1000+ and its accessories have been constructed in compliance with the requirements of EN61010-1, Pollution Degree 2, Installation Category II, FOR INDOOR USE ONLY. This ensures the safety of the analyzer and the user when normal precautions are followed.
- **WARNING:** The analyzer **MUST** be earthed. The power source should be inserted in a socket with a protective ground contact.
- The power source should be inserted before connections are made to measuring or control circuits.
- Do not attempt to remove outer cover without first disconnecting auxiliary and test power supply.
- This instrument must only be serviced by qualified personnel who understand the danger of shock hazards.
- When the instrument is removed from its case hazardous voltages are present.
- The electronic circuitry of this instrument is fully floating with respect to ground. If the instrument is opened and dangerous voltages (above 50V peak) applied to the input terminals then all the circuitry must be considered 'Live'.

- The signal leads must be in good condition with no damage.
- Replace fuses only with the same type and rating as specified in this manual.
- This instrument must be properly rack mounted or must have either two feet and the handle or all four feet making contact on a flat, firm, horizontal surface.

9.3. DECLARATION OF CONFORMITY

DECLARATION OF CONFORMITY	
Manufacturer's Name	Voltech Instruments, Inc.
Manufacturer's Address	11637 Kelly Road Fort Mers, FL 33908 USA
declares, that the product	
Product Name:	Precision Power Analyzer
Model Number:	PM1000+
conforms to the following Product Specifications	
Safety:	BS EN 61010 (2001)
EMC Emissions:	BS EN 61326 (1997, A3:2003): Class A
EMC Immunity:	BS EN 61326 (1997, A3:2003)
	Cabling: RS232, printer and USB cables are all to be shielded and kept to <3m in length.
Supplementary Information:	The product herewith complies with the requirements of the EMC Directive 2004/106/EC for EMC and the Low Voltage Directive 2006/95/EC.
Signed for on behalf of Voltech Instruments Ltd	
February 2009	

10. RELEASE HISTORY

Version 5 to Version 6 (version 4.17 firmware).

- Added a specification for harmonic phase angle.
- Add notes to the Modes section about the available tests in different modes and the effect of switching mode.
- Added section 5.3 which provides information on sending and receiving data.
- Added an example of how to read results back repeatedly from the PM1000+ to section 5.4.
- Added commands ":RNG:VLT:AUT?" and ":RNG:AMP:AUT?" to return whether the unit is in auto range or not (see section 5.2)
- Added section 2.8 covering printing, including the addition of printing via the RS232 port which is available in version 4.17 firmware.

Version 6 to Version 7 (version 4.18 firmware).

- Fixed incorrect references to the voltage and current over range bits, OVV and OVA respectively, in Section 5.5 Status Reporting.
- Fixed incorrect reference to Autozero recurrence in Section 5.3 Sending and Receiving Commands.
- Added explanation for averaging of results (new feature) in Section 4.6 Inputs.
- Added commands ":AVG" and ":AVG?" to set and query the state of averaging of results in Section 5.2 Command Listing.
- Power Factor specification clarified in Section 7.5 Measurement Accuracy.
- Added explanation in Section 4.8 Interfaces, Section 4.10 User Configuration and Section 5.2 Command Listing for change in firmware to leave communication settings unchanged when "*RST" or ":DVC" is sent.

Version 7 to Version 8 (version 4.20 firmware).

- Section 4.5 (Modes) updated to include information IEC current harmonics and IEC voltage flicker modes.
- Changes made the System Configuration section (4.9) in reference to the enabling of IEC mode.

- Specification added to section 7.5 for IEC current harmonics mode and Voltage Flicker mode.
- Added section 6 which details all the available software for the PM1000+.
- Clarified specification examples in section 7.5.

Version 8 to Version 9 (Version 4.21 firmware).

- Change made to Frequency Filter description regarding signals that are a small percentage of range (see section 4.6).
- Added communication commands to configure Harmonic THD parameters in section 5.2.

Version 9 to Version 10 (Version 4.21 firmware).

- Added specification for current channel common mode rejection in section 7.5.
- Add notes to the description of Standby mode in section 4.5.

Version 10 to Version 11 (Version 4.22 firmware).

- Added an improved specification for 45-65Hz, Volts, Amps and Watts.

Version 11 to Version 12 (Version 4.23 firmware).

- Added section 8.5, Language Upload Option.

Version 12 to Version 13 (Version 4.24 firmware).

- The “1” key can now be used to start and stop data-logging on the enhanced comms model. Information was added to section 2.9. This is align the firmware with a new front panel overlay.

Version 13 to Version 14 (Version 4.24 firmware).

- Under product specification added Voltage and Current input capacitance.